

ACCESSORIES
COLLECTION
03

DOIMO
Salotti

DOIMO
Salotti

IL SALOTTO PIÙ FAMOSO D'ITALIA

SOSTENIBILITÀ

INNOVAZIONE

QUALITÀ

DESIGN

CREATIVITÀ

MADE IN ITALY

COMODITÀ

FUNZIONALITÀ

BENESSERE



I Valori Doimo Salotti

I valori di Doimo Salotti si esprimono nell'eccellenza del design, dell'eleganza e della funzionalità, nati da un percorso progettuale di innovazione, sostenibilità ambientale e di personalizzazione del prodotto.

I complementi d'arredo nascono dalla progettazione di prestigiosi designers e vengono concretizzati dal nostro Centro Ricerca e Sviluppo, per poi essere realizzati dalla nostra filiera produttiva tutta Made in Italy.

Da più di 50 anni inoltre il grande valore di Doimo Salotti è l'affidabilità e l'attenzione verso il cliente grazie al nostro reparto post vendita che garantisce un'esperta assistenza su tutti i prodotti.

The values of Doimo Salotti are expressed in the excellence of design, elegance, functionality and comfort, born from a design path of innovation, environmental sustainability and product customization.

The projects of our furniture complements are created by prestigious designers and are implemented by our Research and Development Centre, then they are realized by our production chain all Made in Italy.

For more than 50 years the great value of Doimo Salotti is reliability and attention to the customer thanks to our after-sales department that provides expert assistance on all products.

Les valeurs de Doimo Salotti s'expriment dans l'excellence du design, l'élégance et la fonctionnalité, nées d'un parcours d'innovation, de durabilité environnementale et de personnalisation des produits.

Les projets de nos compléments d'ameublement sont créés par de prestigieux designers et sont mis en œuvre par notre Centre de Recherche et de Développement, puis ils sont réalisés par notre chaîne de production entièrement Made in Italy.

Depuis plus de 50 ans, la grande valeur de Doimo Salotti est la fiabilité et l'attention portée au client grâce à notre service après-vente qui fournit une assistance experte sur tous les produits.

POLTRONCINE	PAG.	6
POUF	PAG.	42
TAVOLINI	PAG.	64
MADIE	PAG.	92
LIBRERIE	PAG.	124
TAPPETI	PAG.	140
PARATI	PAG.	154
LAMPADE	PAG.	170
SPECCHI	PAG.	172
QUADRI	PAG.	174
CUSCINI	PAG.	176

Accessories collection



Poltroncine



Adele PAG. 26



Bergere PAG. 20



Dondolami PAG. 18



Isabel PAG. 28



Jessica PAG. 40



Karin PAG. 24



Kelly PAG. 16



Lounge PAG. 8



Luna PAG. 12



Miranda PAG. 32



Moon PAG. 10



Nora PAG. 38



Roberta PAG. 30



Sara PAG. 34



Tania PAG. 36



Thelma PAG. 22



Zoe PAG. 14



Lounge

Design W. Kraiss

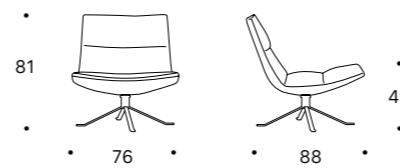

Poltroncina realizzata con basamento girevole in metallo verniciato colore Bronzo Vintage a quattro razze e struttura in multistrato curvato imbottito in poliuretano espanso e cuscineria in piuma. Il basamento è disponibile anche in colore Grigio Piombo. Realizzabile in tessuto, microfibra, ecopelle o pelle sempre non sfoderabile.

Armchair realized with swivel base in Bronzo Vintage painted metal with four spokes and structure in curved plywood padded with polyurethane foam and feather cushioning. The base is also available in Grigio Piombo. Available in fabric, microfiber, eco-leather or leather, always with non-removable covers.

Fauteuil réalisé avec une base pivotante en métal peint en Bronzo Vintage à quatre rayons et une structure en contreplaqué cintré rembourrée avec de la mousse de polyuréthane et un rembourrage en plumes. La base est également disponible en Grigio Piombo. Disponible en tissu, micro-fibre, similcuir ou cuir, toujours avec des housses non amovibles.



Moon

Design Alan Loren



Poltroncina Moon

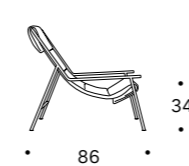
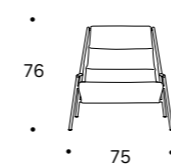

Poltroncina dal design ricercato e minimale dotata di una forte personalità. Realizzata con struttura in metallo verniciato colore Bronzo Vintage di serie, optional disponibile nel colore Grigio Piombo. Anima in cuoietto ricoperto in poliuretano e rivestita in pelle non sfoderabile.

Armchair with a refined and minimalist design with a strong personality. Made with metal frame painted in Bronzo Vintage colour as standard, optional available in Grigio Piombo colour according to samples. Core in polyurethane covered leather and upholstered in non-removable leather.

Fauteuil au design raffiné et minimaliste avec une forte personnalité. Fabriqué avec une armature métallique peinte en standard en Bronzo Vintage, en option disponible en couleur Grigio Piombo. Noyau en cuir recouvert de polyuréthane et revêtement en cuir n'est pas déhoussable.



Luna

Design D.S. Studio



Poltroncina Luna

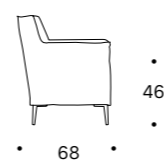
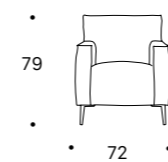

Forme morbide definite dalle esclusive cuciture a labbro. Struttura in legno e imbottitura in poliuretano e misto piuma. Completamente sfoderabile in tessuto, ecopelle o microfibra, in pelle non sfoderabile. Piede di serie in colore Bronzo Vintage, disponibile anche nella finitura alluminio opaco.

Soft shapes defined by exclusive lip stitching. Structure in wood and padding in polyurethane and mixed feather. Completely removable covers in fabric, eco-leather or microfiber. Standard feet in Bronzo Vintage colour, also available in matt aluminium.

Des formes douces définies par des coutures exclusives sur les lèvres. Structure en bois et rembourrage en polyuréthane et en plumes mélangées. Le modèle est entièrement déhoussable en tissu, similicuir ou en microfibre, le cuir n'est pas déhoussable. Pied standard en couleur Bronzo Vintage, également disponible en aluminium mat.



Zoe

Design W. Kraus



Poltroncina Zoe

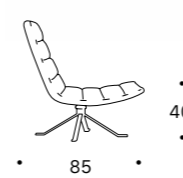
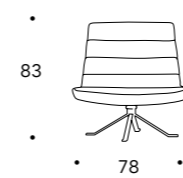

Poltroncina caratterizzata da un elegante trapuntatura, realizzata con basamento girevole in metallo a quattro razze in finitura Bronzo Vintage, optional è disponibile in Grigio Piombo. Struttura in multistrato curvato imbottito in poliuretano espanso e trapuntino in misto piuma. Completamente sfoderabile, rivestibile in tessuto, ecopelle, microfibra o in pelle non sfoderabile.

Armchair characterized by an elegant quilting, made with four-spoke metal swivel base in Bronzo Vintage finish, optional available in Grigio Piombo. Structure in curved plywood padded with polyurethane foam and feather-blend quilt. Completely removable covers in fabric, eco-leather, microfiber. The covers in leather are not removable.

Fauteuil caractérisée par une élégante matelassure, composée d'une base pivotante métallique à quatre branches en finition Bronzo Vintage, disponible en option en Grigio Piombo. Structure en contreplaqué incurvé, rembourrée de mousse de polyuréthane et d'un édedon en plumes. Housse entièrement amovibles, rembourrées en tissu, en microfibre, similicuir ou en cuir non amovible.



Kelly

Design W. Kraus



Poltroncina Kelly

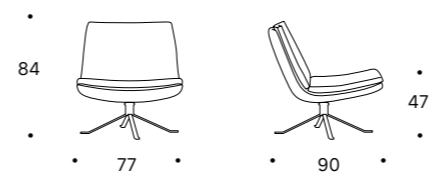

Poltroncina dal design esclusivo realizzata con basamento girevole in metallo a quattro razze in finitura Bronzo Vintage, optional è disponibile in Grigio Piombo. Struttura in multistrato curvato imbottito, cuscini di seduta e schienale in poliuretano. Completamente sfoderabile, rivestibile in tessuto, ecopelle, microfibra o in pelle non sfoderabile.

Exclusively designed low lounge chair with four-spoke metal swivel base in Bronzo Vintage finish, optional available in Grigio Piombo. Structure in curved plywood padded, seat and back cushions in polyurethane. Completely removable covers, upholstered in fabric, eco-leather, microfibre or leather not removable.

Fauteuil Kelly au design exclusif composé d'une base métallique pivotante à quatre rayons en finition Bronzo Vintage, disponible en option en Grigio Piombo. Structure en contreplaqué cintré rembourrée, coussins d'assise et de dossier en polyuréthane. Housses entièrement amovibles, en tissu, en similicuir, en microfibre ou en cuir non amovible.



Dondolami

Design D.S. Studio



Poltroncina Dondolami

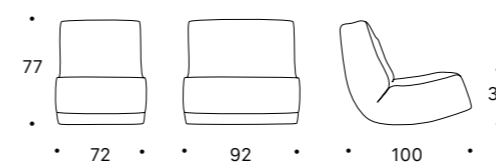

Un'idea dinamica e giovane di poltrona con effetto dondolo. Due elementi indipendenti da 72 e 92 cm possono essere accostati a formare un divano modulare alternativo. Dondolami può essere rivestita in tessuto, microfibra, ecopelle o pelle ed è sempre completamente sfoderabile.

A young and dynamic idea of (futon chair) rocking armchair. Two independent elements of 72 and 92 cm can be combined to form an alternative modular sofa. Dondolami can be upholstered in fabric, eco-leather, microfiber and leather and the covers are always completely removable.

Une idée jeune et dynamique de fauteuil à bascule. Deux éléments indépendants de 72 et 92 cm peuvent être combinés pour former un autre canapé modulaire. Dondolami peut être revêtu de tissu, similicuir, de microfibre et de cuir et la housse est toujours entièrement amovible.



Bergere

Design D.S. Studio



Poltroncina Bergere

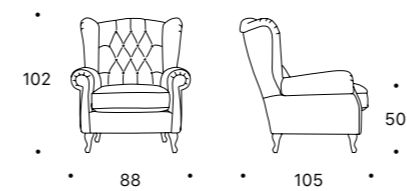

Poltrona dalla forma sinuosa ed elegante, realizzata con struttura in legno e imbottitura in poliuretano e cuscino con anima in poliuretano e piuma. Rivestimento in pelle, ecopelle o microfibra sempre non sfoderabile. Piede di serie in Rovere Cenere, optional in Canaletto o Noce Naturale.

Armchair with sinuous and elegant shape, made with wooden structure and polyurethane padding, cushion with polyurethane and feather core. Upholstery in leather, eco-leather or microfiber, always not removable. Standard feet in Rovere Cenere, optional in Canaletto or Noce Naturale.

Fauteuil fabriqué avec une structure en bois et un rembourrage en polyuréthane et un coussin avec un noyau en polyuréthane et en plumes. Rembourrage en cuir, similicuir ou microfibre, toujours non amovible. Pied standard en Rovere Cenere, en option en Canaletto ou en Noce Naturale.



Thelma

Design Alan Loren



Poltroncina Thelma

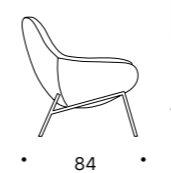
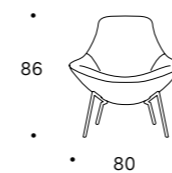

Poltrona dalle forme avvolgenti realizzata con un telaio in metallo curvato rivestito con dello schiumato a freddo. Completamente sfoderabile, rivestibile in tessuto, ecopelle, microfibra o in pelle. Piede in metallo di serie in colore Bronzo Vintage, disponibile anche nel colore Grigio Piombo.

Armchair with enveloping shapes made with a curved metal frame covered with cold foam. Completely removable covers, upholstered in fabric, eco-leather, microfiber or leather. Standard metal feet in lead Bronzo Vintage, available also in Grigio Piombo colour.

Fauteuil aux formes enveloppantes constitué d'une structure métallique incurvée recouverte de mousse froide. Couverture entièrement déhoussable, rembourrée de tissu, de similicuir, de microfibre ou de cuir. Pied standard en métal de couleur Bronzo Vintage, disponible également en Grigio Piombo.



Karin

Design Alan Loren



Poltroncina Karin

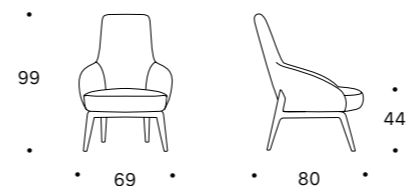

La sua forma avvolgente conferisce un ottimo comfort di seduta. Realizzata con struttura in legno e imbottitura in poliuretano espanso. Rivestibile in tessuto, ecopelle, microfibra o in pelle sempre non sfoderabile. Piede di serie in Rovere Cenere, optional in Canaletto o Noce Naturale.

Its enveloping shape provides excellent sitting comfort. Made with wooden frame and polyurethane foam padding. Upholstered in fabric, eco-leather, microfiber or leather, always non-removable. Standard feet in Rovere Cenere, optional in Canaletto or Noce Naturale.

Sa forme enveloppante offre un excellent confort d'assise. Fabriqué avec un cadre en bois et un rembourrage en mousse de polyuréthane. Rembourrage en tissu, en similicuir, en microfibre ou en cuir, toujours non-amovible. Pied standard en Rovere Cenere, en option en Canaletto ou en Noce Naturale.



Adele

Design D.S. Studio



Poltroncina Adele

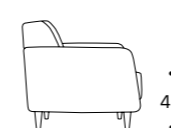

Poltroncina realizzata con struttura in legno e imbottitura in poliuretano espanso. Completamente sfoderabile, rivestibile in tessuto, ecopelle, microfibra o in pelle non sfoderabile. Piede di serie in legno Rovere Cenere o in finitura Canaletto o Noce Naturale. Opzionale disponibile piede curvo in alluminio opaco.

Armchair with wooden frame and polyurethane foam padding. Completely removable cover, upholstered in fabric, eco-leather, microfiber or non-removable leather. Standard feet in Rovere Cenere wood or in Canaletto or Noce Naturale. The curved feet in matt aluminium is available as an option.

Fauteuil avec structure en bois et rembourrage en mousse de polyuréthane. Housse entièrement déhoussable, rembourrée de tissu, de similicuir, de microfibre ou de cuir mais non amovible. Pied standard en bois de Rovere Cenere ou en finition Canaletto ou Noce Naturale. Le pied courbé en aluminium mat est également disponible en option.



Isabel

Design D.S. Studio



Poltroncina Isabel

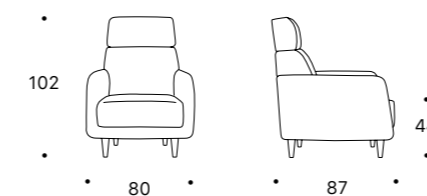

Poltrona realizzata con struttura in legno e imbottitura in poliuretano espanso. Completamente sfoderabile, rivestibile in tessuto, ecopelle, microfibra o in pelle non sfoderabile. Piede di serie in legno Rovere Cenere, optional in finitura Canaletto o Noce Naturale. Come optional è disponibile anche il piede curvo in alluminio opaco.

Armchair with wooden frame and polyurethane foam padding. Completely removable cover, upholstered in fabric, eco-leather, microfiber or non-removable leather. Standard feet in Rovere Cenere wood, optional in Canaletto or Noce Naturale wood. The curved feet in matt aluminium is also available as an option.

Fauteuil avec structure en bois et rembourrage en mousse de polyuréthane. Housse entièrement déhoussable, rembourrée de tissu, de similicuir, de microfibre ou de cuir mais non amovible. Pied standard en bois de Rovere Cenere, en option en finition Canaletto ou Noce Naturale. Le pied courbé en aluminium mat est également disponible en option.

Roberta

Design D.S. Studio



Poltroncina Roberta

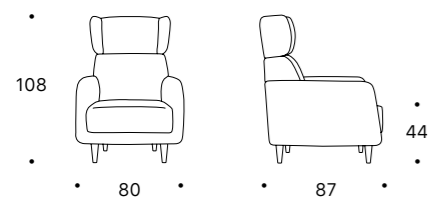

Poltrona realizzata con struttura in legno e imbottitura in poliuretano espanso. Completamente sfoderabile, rivestibile in tessuto, ecopelle, microfibra o in pelle non sfoderabile. Piede di serie in legno Rovere Cenere, optional in finitura Canaletto o Noce Naturale. In alternativa è disponibile anche il piede curvo in alluminio opaco.

Armchair with wooden frame and polyurethane foam padding. Completely removable cover, upholstered in fabric, eco-leather, microfiber or non-removable leather. Standard feet in Rovere Cenere wood, optional in Canaletto or Noce Naturale. The curved feet in matt aluminium is available as an option.

Fauteuil avec structure en bois et rembourrage en mousse de polyuréthane. Housse entièrement déhoussable, rembourrée de tissu, de similicuir, de microfibre ou de cuir non amovible. Pied standard en bois Rovere Cenere, en option en finition Canaletto ou Noce Naturale. Le pied courbé en aluminium mat est également disponible en option.

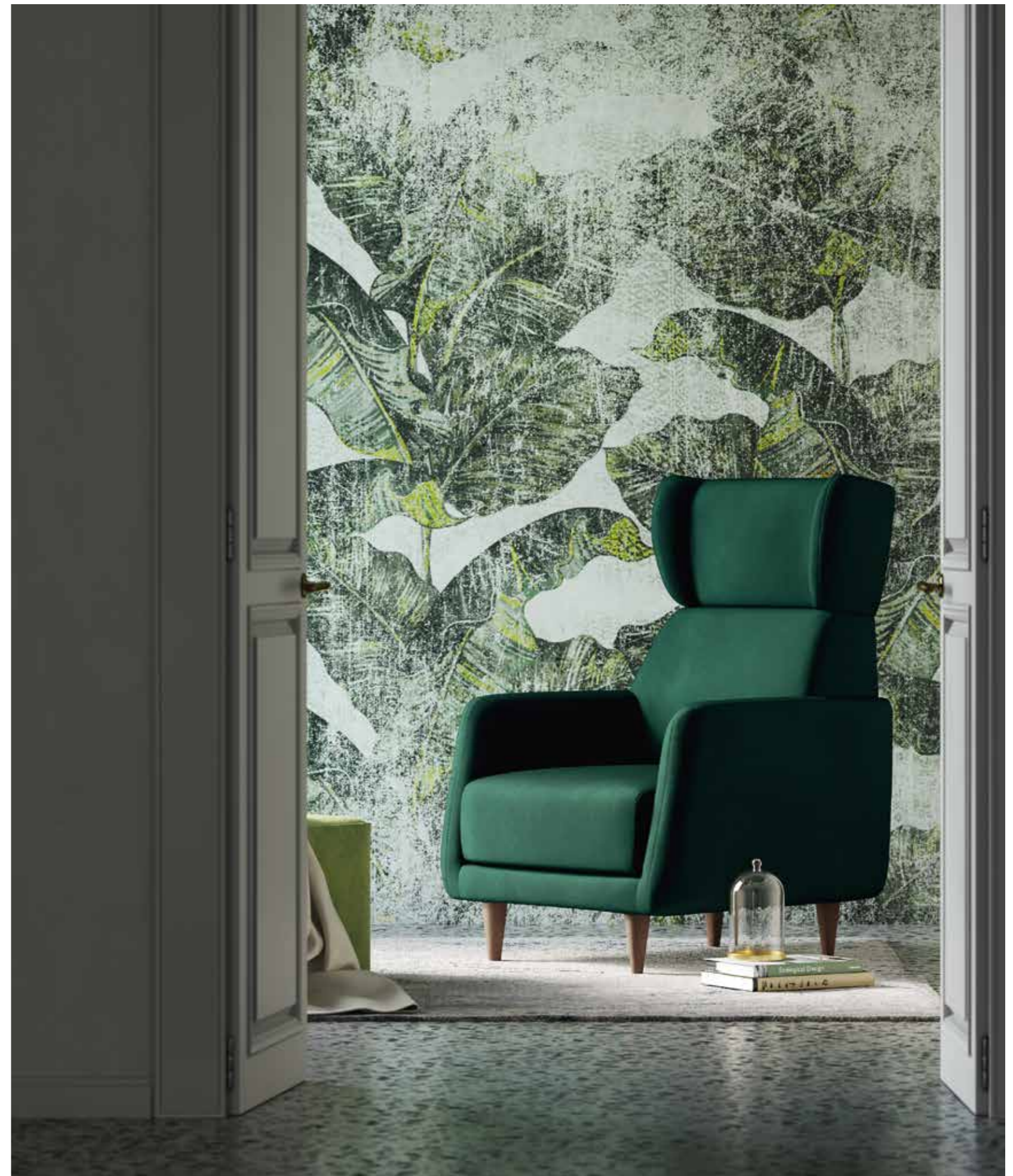



Miranda

Design D.S. Studio



Poltroncina Miranda

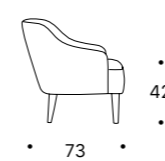
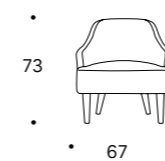

Poltroncina con struttura in legno e imbottitura in poliuretano espanso. Rivestibile in tessuto, ecopelle, microfibra o in pelle sempre non sfoderabile. Piede di serie in Rovere Cenere, optional in Canaletto o Noce Naturale. Poltroncina adatta per salotti, entrate e camere da letto.

Armchair with wooden frame and polyurethane foam padding. Upholstered in fabric, eco-leather, microfiber or leather, always with non-removable covers. Standard feet in Rovere Cenere, optional in Canaletto or Noce Naturale. Armchair suitable for living rooms, entrances and bedrooms.

Fauteuil avec structure en bois et rembourrage en mousse de polyuréthane. Rembourrage en tissu, en similicuir, en microfibre ou en cuir, toujours avec des housses non amovibles. Pied standard en Rovere Cenere, en option en Canaletto ou en Noce Naturale. Petit fauteuil adapté aux salles de séjour, aux entrées et aux chambres à coucher.



Sara

Design W. Kraus



Poltroncina Sara

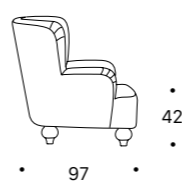
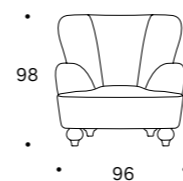

Poltrona dalla forma avvolgente con schienale alto e accogliente, realizzata con struttura in legno e imbottitura in poliuretano espanso. Completamente sfoderabile, rivestibile in tessuto, ecopelle, microfibra o in pelle non sfoderabile. Piede di serie in legno Rovere Cenere, optional in finitura Canaletto o Noce Naturale.

Wrap-around armchair with high and comfortable backrest, made with wooden frame and polyurethane foam padding. Completely removable cover, upholstered in fabric, eco-leather, microfiber or non removable leather. Standard feet in Rovere Cenere wood, optional in Canaletto or Noce Naturale finish.

Fauteuil enveloppant avec un dossier haut et confortable, fabriqué avec une structure en bois et un rembourrage en mousse de polyuréthane. Housse entièrement déhoussable, rembourrée de tissu, de similicuir, de microfibre ou de cuir non amovible. Pied standard en bois de Rovere Cenere, en option en finition Canaletto ou Noce Naturale.



Tania

Design D.S. Studio



Poltroncina Tania

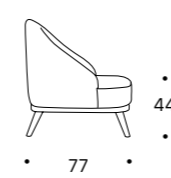
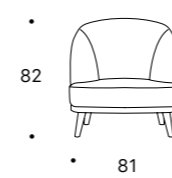

Poltroncina dalla forma elegante realizzata con struttura in legno e imbottitura in poliuretano espanso. Completamente sfoderabile, rivestibile in tessuto, ecopelle, microfibra o in pelle non sfoderabile. È realizzata con basamento in legno disponibile nelle finiture Rovere Cenere, Canaletto o Noce Naturale.

Elegantly shaped low lounge chair with wooden frame and polyurethane foam padding. Completely removable cover, upholstered in fabric, eco-leather, microfiber or non-removable leather. It is made with a wooden base available in Rovere Cenere, Noce Naturale or Canaletto finishes.

Forme élégante avec structure en bois et rembourrage en mousse de polyuréthane. Housse entièrement déhoussable, rembourrée de tissu, de similicuir, de microfibre ou de cuir non amovible. Il est fabriqué avec une base en bois disponible en finition Rovere Cenere, Canaletto ou Noce Naturale.



Nora

Design W. Kraus



Poltroncina Nora

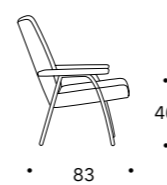
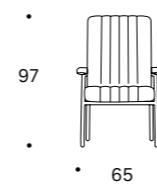

Poltroncina con schienale alto dalla linea vintage, realizzata con struttura in legno e imbottitura in poliuretano espanso. Telaio tubolare portante in metallo colore Bronzo Vintage, disponibile come optional anche nel colore Grigio Piombo. Completamente sfoderabile, rivestibile in tessuto, ecopelle, microfibra o in pelle non sfoderabile.

Armchair with high backrest and vintage look, made with wooden frame and polyurethane foam padding. Standard metal tubular supporting frame in Bronzo Vintage, available as optional also in Grigio Piombo colour. Completely removable cover, upholstered in fabric, eco-leather, microfiber or non-removable leather.

Fauteuil à dossier haut, aux formes vintage, constitué d'une structure métallique incurvée recouverte de mousse froide. Cadre tubulaire en métal de couleur Bronzo Vintage, disponible également en Grigio Piombo. Housse entièrement déhoussable, rembourrée de tissu, de similicuir, de microfibre ou de cuir mais non amovible.



Fauteuil au design exclusif en forme de diamant, fabriqué avec une structure en contreplaqué et un rembourrage en mousse de polyuréthane. Jessica est fabriqué en deux tailles et peut être recouvert de tissu, de similicuir, de microfibre ou de cuir, toujours avec des housses non amovibles. Pied standard en bois de Rovere Cenere ou en finition Canaletto ou Noce Naturale.

Jessica

Design W. Kraus



Poltroncina Jessica

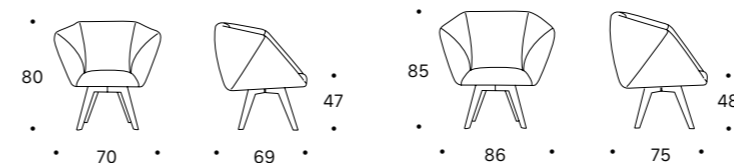

Poltroncina dalla esclusiva forma diamantata, realizzata con struttura in multistrato e imbottitura in poliuretano espanso. Jessica è realizzata in due misure ed è rivestibile in tessuto, eco-pelle, microfibra o in pelle sempre non sfoderabile. Piede di serie in legno Rovere Cenere, optional in finitura Noce Naturale o Canaletto.

Armchair with exclusive diamond shape, made with plywood structure and polyurethane foam padding. Jessica is made in two sizes and can be upholstered in fabric, eco-leather, microfiber or leather, always with non-removable covers. Standard feet in Rovere Cenere wood, optional in Noce Naturale or Canaletto.

Pouf



Beverly PAG. 48



Bound PAG. 55



Calvin PAG. 46



Denis PAG. 59



Fly PAG. 58



Kip PAG. 45



Lupin PAG. 54



Mitos PAG. 51



Porter PAG. 56



Rik PAG. 44



Ronny PAG. 60



Sassi PAG. 52



Tiger PAG. 47



Tod PAG. 50

Rik

Design W. Kraus



Pouf Rik

Pouf dal gusto nordico con forma a sgabello, realizzato con un supporto in legno e cuscino in poliuretano espanso. Piede di serie in Rovere Cenere, optional in finitura Canaletto o Noce Naturale. Rivestibile in tessuto, ecopelle, microfibra o pelle, sempre completamente sfoderabile.

Nordic taste pouf with stool shape, made with a wooden structure and polyurethane foam padding. Standard feet in Rovere Cenere, optional Canaletto or Noce Naturale finish. Upholstered in fabric, eco-leather, microfiber or leather, always completely removable.

Pouf au goût nordique en forme de tabouret, réalisé avec un support en bois et un rembourrage en mousse de polyuréthane. Pied standard en finition Rovere Cenere, en option Canaletto ou Noce Naturale. Rembourrage en tissu, en similicuir, en microfibre ou en cuir, toujours entièrement amovible.

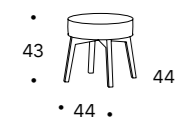

Kip

Design Loren Alan



Pouf Kip

Realizzato con un elemento imbottito in poliuretano espanso a doppia densità, sostenuto da un elegante telaio in legno, di serie in Rovere Cenere. Disponibile optional anche in finitura Canaletto o Noce Naturale. Rivestibile in tessuto, ecopelle, microfibra o pelle, sempre sfoderabile.

Made with a double density polyurethane foam padded element, supported by an elegant wooden frame, standard in Rovere Cenere or Canaletto or Noce Naturale finish. Upholstered in fabric, eco-leather, microfiber or leather, always completely removable.

Fabriqué avec un élément rembourré de mousse de polyuréthane à double densité, soutenu par un élégant cadre en bois, en finition Rovere Cenere, Canaletto ou Noce Naturale. Rembourrage en tissu, en similicuir, en microfibre ou en cuir, toujours entièrement amovible.

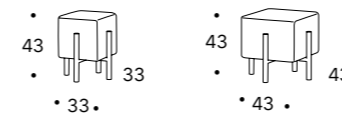

Calvin

Design D.S. Studio



Pouf Calvin

L'elegante lavorazione capitonné del cuscino rende Calvin un elemento perfetto di continuità con la poltrona Bergère. Struttura in legno imbottitura del cuscino in poliuretano espanso. Rivestibile in pelle, ecopelle o microfibra sempre non sfoderabile. Piede di serie in Rovere Cenere, optional in Canaletto o Noce Naturale.

The elegant cushion capitonné workmanship makes Calvin a perfect element of continuity with the Bergère armchair. Wooden frame padded with polyurethane foam. Upholstered in fabric, eco-leather, microfiber or leather, always with non-removable covers. Standard feet in Rovere Cenere, optional in Canaletto or Noce Naturale.

L'élégante fabrication du coussin capitonné fait de Calvin un élément de continuité parfait avec le fauteuil Bergère. Cadre en bois rembourré de mousse de polyuréthane. Rembourrés en cuir, en similicuir ou en microfibre, toujours avec des housses non amovibles. Pied standard en Rovere Cenere, en option en Canaletto ou en Noce Naturale.

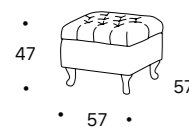

Tiger

Design W. Kraus



Pouf Tiger

Pouf realizzato con un supporto in legno e poliuretano espanso. Piede di serie in metallo finitura Indian Brown, optional disponibile nel colore Grigio Piombo. Completamente sfoderabile, rivestibile in tessuto, ecopelle, microfibra o in pelle non sfoderabile.

Pouf made with a support in wood and polyurethane foam. Standard feet in Indian Brown metal finish, as an option available in colour Grigio Piombo. Completely removable covers, upholstered in fabric, eco-leather, microfiber or non removable leather cover.

Pouf réalisé avec un support en bois et mousse de polyuréthane. Pied standard en métal finition Indian Brown, ou en option disponible en couleur Grigio Piombo. Housses entièrement amovibles en tissu, similicuir, microfibre ou en cuir mais non amovibles.

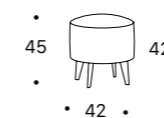



Beverly

Design Angelo Armano



Pouf Beverly

Cuscino in poliuretano, rivestibile in tessuto, ecopelle, microfibra o pelle, sempre completamente sfoderabile. Piano in legno di serie in Rovere Cenere oppure optional in finitura Canaletto o Noce Naturale, disponibile anche nei colori laccati. Piede di serie in metallo Bronzo Vintage, optional disponibile nei colori laccati a campionario.

Cushion in polyurethane foam, upholstered in fabric, eco-leather, microfiber or leather, always completely removable. Standard wooden top in Rovere Cenere or Canaletto or Noce Naturale finish, also available in lacquered colours. Standard metal feet in Bronzo Vintage finish, optional available in lacquered colours.

Coussin en polyuréthane, recouvert de tissu, similicuir, microfibre ou en cuir, toujours entièrement déhoussable. Plateau en bois finition Rovere Cenere ou Canaletto ou Noce Naturale, également disponible en couleurs laquées. Pied métallique standard en Bronzo Vintage, en option disponible en couleurs laquées.

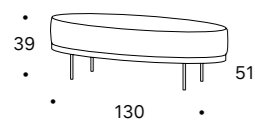



Pouf Tod

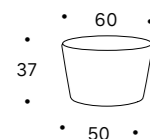

Pouf dalla forma conica, realizzato in poliuretano espanso a doppia densità. Ideale per qualsiasi ambiente, Tod offre una comoda seduta alternativa. Oltre che nello spazio living, Tod può essere inserito nelle camerette da bambino. È rivestibile in tessuto, ecopelle, microfibra o pelle, sempre completamente sfoderabile.

Pouf with a slightly conical shape, made of double density polyurethane foam. Ideal for any environment, Tod offers a comfortable alternative seat. In addition to the living space, Tod can also be placed in children's bedrooms. Upholstered in fabric, eco-leather, microfiber or leather, always completely removable.

Pouf de forme légèrement conique, en mousse de polyuréthane double densité. Idéal pour tout environnement, le Tod offre un siège alternatif confortable. En plus de l'espace de vie, Tod peut également être placé dans les chambres d'enfants. Rembourrage en tissu, en similicuir, en microfibre ou en cuir, toujours entièrement amovible.

Pouf Mitos



Pouf cilindrico leggermente bombato nella parte superiore. Disponibile in due misure, realizzato in poliuretano espanso a doppia densità. Grazie alla sua semplicità, Mitos è facilmente abbinabile a qualsiasi salotto. Comodo per le entrate, cabine armadio o camerette. Rivestibile in tessuto, ecopelle, microfibra o pelle, sempre completamente sfoderabile.

Slightly rounded cylindrical pouf at the top. Available in two sizes, made of double density polyurethane foam. Thanks to its simplicity, Mitos can be easily combined with any living room. Convenient for entrances, walk-in closets or bedrooms. Upholstered in fabric, eco-leather, microfiber or leather, always completely removable.

Pouf cylindrique légèrement arrondi au sommet. Disponible en deux tailles, en mousse de polyuréthane double densité. Grâce à sa simplicité, Mitos peut être facilement combiné avec n'importe quelle salle de séjour. Pratique pour les entrées, les dressing ou les chambres. Rembourrage en tissu, similicuir, microfibre ou cuir, toujours complètement amovible.



Sassi

Design D.S. Studio

Pouf Sassi

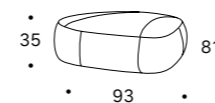
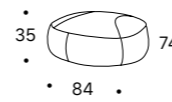
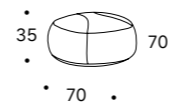

Imbottitura realizzata con materiali tecnici che offrono un'ottima resistenza alla compressione garantendo una seduta portante. La particolare cucitura superiore è sempre rifinita con un canneté di colore antracite. Disponibile in 3 misure, rivestibile in tessuto, ecopelle, microfibra o pelle, sempre completamente sfoderabile.

Padding made of technical materials that guarantee excellent resistance to compression and a load-bearing seat. The particular upper stitching is always finished with an anthracite coloured canneté. Available in 3 sizes, coverable in fabric, Eco leather, microfiber or leather, always completely removable.

Rembourrage fait de techniques matériaux qui garantissent une excellente résistance à la compression et un siège porteur. La couture supérieure particulière est toujours terminée par un canneté de couleur anthracite. Disponible en 3 tailles, revêtu en tissu, en similicuir, en microfibre ou en cuir, toujours entièrement amovible.

Lupin

Design D.S. Studio



Pouf Lupin

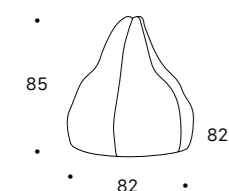

Lupin è il pouf a sacco per eccellenza, comodo per giocare ai videogiochi, bello e divertente come soluzione d'arredo. Un pouf a forma di pera realizzato in polistirolo racchiuso in una sacca contenitiva. Rivestibile in tessuto, ecopelle, microfibra o pelle, sempre completamente sfoderabile.

Lupin is the pouf-bag par excellence, comfortable to play video games, beautiful and fun as a furnishing solution. A pear-shaped pouf made of polystyrene enclosed in a storage bag. Upholstered in fabric, eco-leather, microfiber or leather, always completely removable.

Lupin est le pouf-bag par excellence, confortable pour jouer aux jeux vidéo, beau et amusant comme solution d'ameublement. Un pouf en forme de poire en polystyrène enfermé dans un sac de rangement. Rembourrage en tissu, en similicuir, en microfibre ou en cuir, toujours entièrement amovible.

Bound

Design D.S. Studio



Pouf Bound

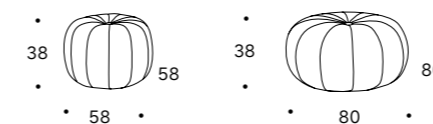

Bound è perfetto per arredare con fantasia qualsiasi ambiente. Può essere realizzato in monocolore oppure in vari colori fino ad un massimo di quattro. L'imbottitura è realizzata con materiali vari che garantiscono un'ottima resistenza alla compressione. Rivestibile in tessuto, ecopelle o microfibra, sempre completamente sfoderabile.

Bound is perfect to furnish any environment with creativity. It can be made in one colour or in various colours up to a maximum of four. The padding is made of various materials that guarantee excellent resistance to compression. It can be upholstered in fabric, eco-leather or microfiber, always completely removable.

Bound est parfait pour décorer avec créativité n'importe quel environnement. Il peut être réalisé en une seule couleur ou en plusieurs couleurs, jusqu'à un maximum de quatre. Le rembourrage est constitué de différents matériaux qui garantissent une excellente résistance à la compression. Il peut être recouvert de tissu, de similicuir ou de microfibre, toujours entièrement amovible.

Porter

Design D.S. Studio



Pouf Porter

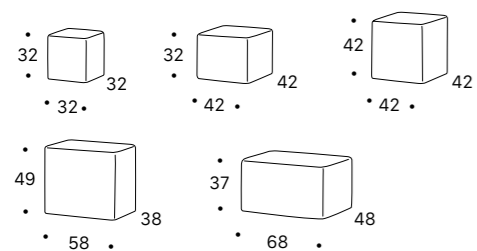

Cinque diverse misure di pouf realizzati con imbottiture in poliuretano espanso a doppia densità. Facilmente abbinabili a qualsiasi situazione in tutti gli ambienti della casa dalla zona living alla camera dei bambini. Rivestibili in tessuto, ecopelle, microfibra o pelle, sempre completamente sfoderabili.

Five different sizes of pouf made with double density polyurethane foam padding. Easily combinable with any situation in all rooms of the house from the living area to the children's room. Upholstered in fabric, eco-leather, microfiber or leather, always completely removable.

Cinq tailles différentes de pouf fabriqués avec un rembourrage en mousse de polyuréthane double densité. Facilement combinable avec dans toutes les pièces de la maison, du salon à la chambre des enfants. Revêtu en tissu, en similicuir, en microfibre ou en cuir, toujours entièrement amovible.

Fly

Design D.S. Studio



Pouf Fly

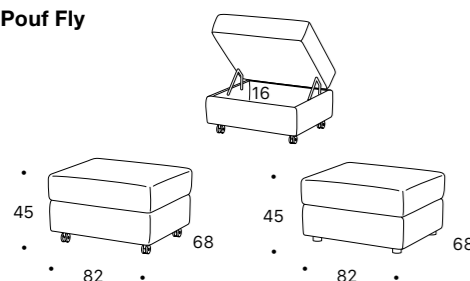

Pouf con vano, con struttura in legno, rivestita con vellutino accoppiato. La seduta è realizzata in poliuretano espanso. Il vano interno è profondo 16 cm. Fly può essere richiesto con il piede seminascosto in legno colore 021 Marrone Caffè o con le ruote colore Argento. Rivestibile in tessuto, ecopelle, microfibra o pelle, sempre completamente sfoderabile.

Pouf with storage made with wooden structure and polyurethane foam padding. The inner compartment is 16 cm deep. The pouf can be requested with the half hidden feet in 021 Marrone Caffè color wood or with Silver wheels. Upholstered in fabric, eco-leather, microfiber or leather, completely removable.

Pouf avec compartiment en structure en rembourrage en bois et polyuréthane étendu. Le compartiment interne est profond 16 cm. Fly peut être demandé avec le pied à moitié caché en bois coloré 021 Marrone Caffè ou avec roues de couleur Argent. Revêtu de tissu, éco-cuir, microfibre ou cuir, entièrement déhoussable.

Denis

Design D.S. Studio



Pouf Denis

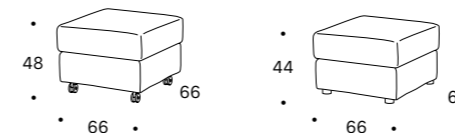

Pouf realizzato con struttura in legno, rivestita con vellutino accoppiato. La seduta è realizzata in poliuretano espanso. Fornito di serie con i piedi in plastica nera, optional è disponibile con le ruote color Argento. Denis è un pouf universale adatto a qualsiasi salotto. Rivestibile in tessuto, ecopelle, microfibra o pelle, completamente sfoderabile, tranne la versione in pelle.

Pouf made with wooden structure and polyurethane foam cushion. Supplied as standard with the optional black plastic feet but also available with the Silver wheels. Denis is a universal pouf suitable for any living room. Upholstered in fabric, eco-leather, microfiber or leather, completely removable, except the leather version.

Pouf à structure en bois et coussin en mousse de polyuréthane. Livré en standard avec le pied en plastique noir disponible en option avec les roulettes Argentées. Denis est un pouf universel qui convient à tous les canapés. Revêtu en tissu, en similicuir, en microfibre ou en cuir, entièrement amovible, sauf pour la version en cuir.



Ronny

Design D.S. Studio



Pouf Ronny

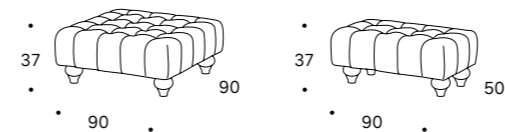

Pouf dal gusto neoclassico rifinito con un'elegante lavorazione con impuntature. Struttura in legno e imbottitura in poliuretano espanso. Piede di serie in legno Rovere Cenere, optional in finitura Canaletto o Noce Naturale. Rivestibile in tessuto, ecopelle, microfibra o in pelle sempre non sfoderabile.

Pouf with a neoclassical taste finished with an elegant stitching work. Wooden structure and polyurethane foam padding. Standard feet in Rovere Cenere wood or in Canaletto or Noce Naturale finish. Upholstered in fabric, eco-leather, microfiber or leather, always not removable.

Pouf au goût néoclassique, fini par des coutures élégantes. Structure en bois et rembourrage en mousse de polyuréthane. Pied standard en bois de Rovere Cenere ou en finition Canaletto ou Noce Naturale. Rembourrage en tissu, en similicuir, en microfibre ou en cuir, toujours non amovible.



Tavolini



Beverly PAG. 88



Elisse PAG. 70



Evan PAG. 66



Floyd PAG. 68



Gocce PAG. 80



Hugo PAG. 82



Kirk PAG. 76



Leonard PAG. 90



Nexus PAG. 74



Otis PAG. 86



Plane PAG. 78



Roy PAG. 72



Terry PAG. 84



Evan

Design D.S. Studio



Tavolino Evan

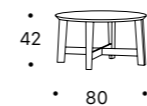

• 80 •

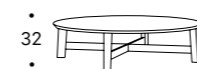

• 130 •

Evan è un tavolino dalle linee tradizionali caratterizzato da un importante basamento in legno. Il piano in MDF è disponibile nei colori laccati a campionario; nella misura da 80 cm si può realizzare il piano in pietra Gray Stone. Il basamento in legno può essere richiesto nelle finiture Rovere Cenere, Canaletto o Noce Naturale.

Evan is a coffee table with traditional lines characterized by an important wooden structure. The MDF top is available in lacquered colours. In the size of 80 cm the Gray Stone top is available. The wooden base can be requested in Rovere Cenere, Canaletto or Noce Naturale finishes.

Evan est une table basse aux lignes traditionnelles caractérisée par une importante structure en bois. Le plateau en MDF est disponible dans les couleurs laquée de la gamme. Dans la taille de 80 cm, est disponible le plateau en pierre Gray Stone. La base en bois peut être demandée en finition Rovere Cenere, Canaletto ou Noce Naturale.



Floyd

Design W. Kraus



Tavolino Floyd

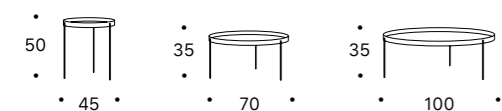

Tavolino dall'esile struttura in metallo verniciato Bronzo Vintage. Il piano può essere realizzato in legno, in nobilitato, nei colori laccati a campionario o in pietra Gray Stone. Il piano in pietra Gray Stone può essere inserito nelle misure da 45 e 70 cm. Il tavolino da 45 cm può essere gradevolmente accostato in sovrapposizione ai tavolini bassi da 70 o da 100 cm.

Coffee table with slender frame in Bronzo Vintage painted metal. The top can be made of wood veneered, in melamine, in the lacquered colours of the range or in Gray Stone. The Gray Stone top can only be inserted in sizes 45 and 70 cm. The 45 cm coffee table can be fitted on top of the lower 70 and 100 cm versions.

Table basse avec un cadre en métal peint Bronzo Vintage. Le plateau peut être en bois plaqué, en mélamine, en couleurs laquées ou en pierre Gray Stone. Le plateau en pierre Gray Stone ne peut être inséré que dans les tailles 45 et 70 cm. La table basse de 45 cm peut être montée sur les versions inférieures de 70 et 100 cm.



Elisse

Design D.S. Studio



Tavolino Elisse

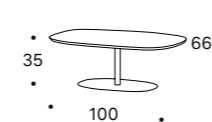
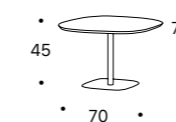
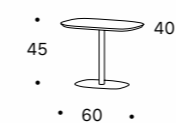

Linee arrotondate essenziali che ben si adattano a qualsiasi ambiente. Il basamento è in metallo verniciato Bronzo Vintage, disponibile anche nei colori laccati a campionario. Il piano può essere richiesto nei vari colori laccati o della stessa tonalità del basamento. Elisse è disponibile in tre diverse misure, con altezze diverse, consentendo composizioni e sovrapposizioni particolari ed eleganti.

Essential rounded lines that adapt well to any environment. The base is made of Bronzo Vintage painted metal, also available in lacquered colours. The top can be requested in the various lacquered colours. Elisse is available in three different sizes, with different heights, allowing particular and elegant compositions and overlaps.

Des lignes arrondies essentielles qui s'adaptent bien à tout environnement. La base est en métal peint en Bronzo Vintage, également disponible en couleurs laquées. Le plateau peut être peint dans les différentes couleurs de laque de la même nuance que la base. Elisse est disponible en trois tailles différentes, avec des hauteurs différentes, permettant des compositions et des superpositions particulières et élégantes.



Roy

Design D.S. Studio



Tavolino Roy

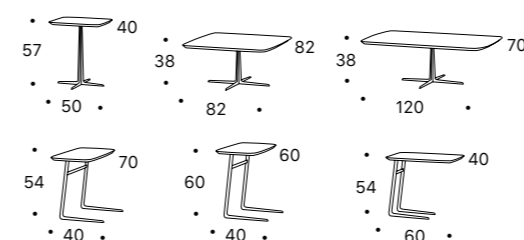

Programma di tavolini che rappresentano il connubio perfetto tra eleganza e funzionalità. Il basamento è in metallo verniciato Bronzo Vintage, disponibile anche nei colori laccati a campionario. Il piano può essere realizzato con le finiture in legno Rovere Cenere, Canaletto e Noce Naturale o laccato nei vari colori disponibili a campionario.

A range of tables that represent the perfect combination of elegance and functionality. The base is in Bronzo Vintage painted metal, also available in lacquered colours. The top can be made in Rovere Cenere, Canaletto and Noce Naturale wood finishes or lacquered in the various colours available.

Une gamme de tables qui représente la combinaison parfaite de l'élégance et de la fonctionnalité. La base est en métal peint en Bronzo Vintage, également disponible en couleurs laquées. Le top peut être réalisé en Rovere Cenere, Canaletto et Noce Naturale ou laqué dans les différentes couleurs disponibles.



Nexus

Design D.S. Studio



Tavolino Nexus

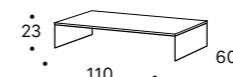
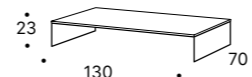
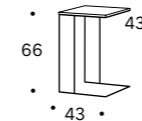
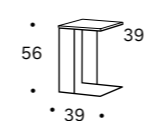

Collezione di tavolini e servetti con struttura in metallo verniciato Bronzo Vintage, disponibile anche nei colori laccati a campionario. Il piano può essere realizzato con le finiture in legno Noce Naturale, Canaletto o Rovere Cenere; in nobilitato Asia, India, Terra o Spatolato oppure nei vari colori laccati disponibili a campionario.

Collection of coffee tables with frame in Bronzo Vintage painted metal, also available in lacquered colours. The top can be made with the finishes in Noce Naturale, Canaletto or Rovere Cenere; in melamine Asia, India, Terra or Spatolato or in the various lacquered colours available in the sample book.

Collection de tables et de tables basses avec cadre en métal peint en Bronzo Vintage, également disponible en couleurs laquées. Le plateau peut être réalisé avec les finitions en Noce Naturelle, Canaletto ou Rovere Cenere; en mélamine Asia, India, Terra ou Spatolato ou dans les différentes couleurs laquées disponibles en échantillons.



Kirk

Design W. Kraus



Tavolino Kirk

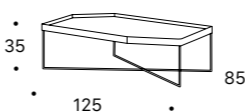
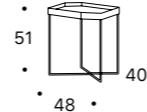

Tavolino di design dalla forma irregolare con struttura in metallo verniciato Bronzo Vintage e piani disponibili nelle finiture in legno, nobilitato, laccato o in pietra Gray Stone. Nel tavolino da 125x85 è possibile realizzare anche la composizione di due materiali con taglio obliquo: pietra Gray Stone e laccato, pietra Gray Stone e legno oppure pietra Gray Stone e nobilitato.

Design coffee table with irregular shape and structure in Bronzo Vintage painted metal and top available in wood veneered, melamine, lacquered or Gray Stone finishes. In the 125x85 coffee table it is also possible to create the composition of two oblique cut materials: Gray Stone and lacquered, Gray Stone and wood or Gray Stone with a melamine finish.

Table basse de design de forme irrégulière avec structure en métal peint en Bronzo Vintage et top disponible en finition bois plaqué, mélamine, laqué ou pierre Gray Stone. Dans la table basse 125x85, il est également possible de créer la composition de deux matériaux de coupe oblique: pierre Gray Stone et laqué, Gray Stone et bois ou Gray Stone avec une finition mélamine.



Plane

Design D.S. Studio



Tavolino Plane

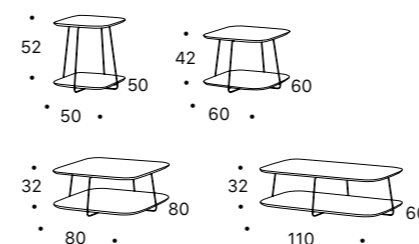

Elegante collezione di tavolini realizzati con una leggera struttura in metallo curvato verniciato Bronzo Vintage di serie, optional nei colori laccati. I ripiani possono essere richiesti con le finiture in legno Rovere Cenere, Canaletto e Noce Naturale oppure laccati nei vari colori disponibili, anche in colore diverso dalla struttura. I due piani del tavolino vengono realizzati sempre con la stessa finitura.

Elegant collection of coffee tables made with a light structure in curved and painted metal rods, Bronzo Vintage finish or in lacquered colours. The shelves can be requested with Rovere Cenere, Canaletto and Noce Naturale wood finishes or lacquered in the various colours available, even in a colour different from the structure. The two tops of the coffee table are always made with the same finish.

Élégante collection de tables basses à structure légère de métal courbées et peintes en Bronzo Vintage ou dans des couleurs laquées. Les étagères peuvent être demandées avec des finitions en Rovere Cenere, Canaletto, Noce Naturale ou laquées dans les différents couleurs disponibles, même dans une couleur différente de la structure. Les deux plateaux sont toujours réalisés avec la même finition.



Gocce

Design D.S. Studio



Tavolino Gocce

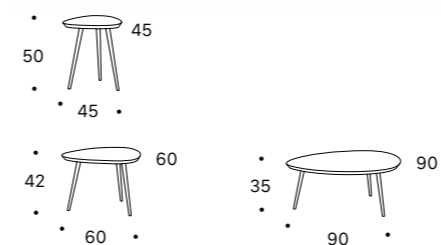

Tavolino moderno, dal design scandinavo costituito da un piano a forma triangolare con angoli arrotondati, realizzabile nelle finiture laccate a campionario. Le gambe in legno sono disponibili nelle finiture Rovere Cenere, Canaletto e Noce Naturale oppure laccate nei vari colori in campionario. Le diverse forme ed altezze permettono di realizzare composizioni esclusive e sofisticate.

Modern coffee table with scandinavian design consisting of a triangular-shaped top with rounded corners, available in lacquered finishes. The wooden legs are available in Rovere Cenere, Canaletto and Noce Naturale finishes or lacquered in the various colours available. The different shapes and heights make it possible to create exclusive and sophisticated compositions.

Table basse moderne au design scandinave composée d'un plateau de forme triangulaire aux angles arrondis, disponible en finition laquée. Les pieds en bois sont disponibles dans les finitions Rovere Cenere, Canaletto, Noce Naturale ou laqués dans les différents couleurs disponibles. Les différentes formes et hauteurs permettent de créer des compositions exclusives.



Hugo

Design Angelo Armano



Tavolino Hugo

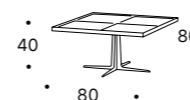
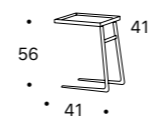

La collezione di tavolini Hugo è l'espressione della massima personalizzazione. Il basamento è in metallo verniciato Bronzo Vintage, disponibile anche nei colori laccati a campionario. Il piano è realizzato in nobilitato e può essere personalizzato con l'integrazione nei riquadri degli inserti removibili disponibili nelle finiture laccate oppure con vetro Serigrafato o trasparente Extra Chiaro.

The collection of Hugo coffee tables is the expression of the maximum customization. The base is in Bronzo Vintage lacquered metal, also available in lacquered colours. The top is made of melamine and can be personalized with the integration in the squares of inserts available in lacquered finishes or with Screen-printed or Extra Clear glass.

La collection de tables basses Hugo est l'expression du maximum de personnalisation. La base est en métal laqué Bronzo Vintage, également disponible en couleurs laquées. Le plateau est en mélamine et peut être personnalisé grâce à l'intégration dans les carreaux d'inserts disponibles dans les finitions laquées ou avec du verre Sérigraphié ou Extra Clair.



Terry

Design Angelo Armano



Tavolino Terry

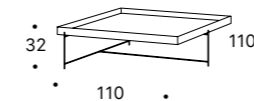
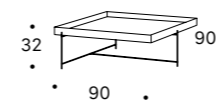
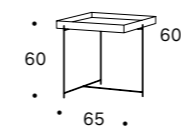

I tavolini Terry sono caratterizzati dalle linee minimali della struttura in metallo verniciato Bronzo Vintage di serie, disponibile anche nei colori laccati a campionario. Il piano a vassoio è realizzato in nobilitato e può essere personalizzato con l'integrazione di un inserto disponibile nelle finiture laccate o con vetro Serigrafato o Extra Chiaro.

Terry coffee tables are characterized by the minimalist lines of the structure in Bronzo Vintage painted metal, also available in lacquered colors. The tray top is made of melamine and can be customized with the integration of an insert available in lacquered finishes or with Screen-printed or Extra Clear glass.

Les tables basses Terry sont caractérisées par les lignes minimalistes de la structure en métal peint en Bronzo Vintage, également disponible en couleurs laquées. Le plateau est en melamine et peut être personnalisé avec l'intégration d'un insert disponible en finition laquée ou avec du verre Sérigraphié ou Extra Clair.



Otis

Design Angelo Armano



Tavolino Otis

Esclusività e personalizzazione sono le prerogative dei tavolini Otis. Il basamento è in metallo verniciato Bronzo Vintage, disponibile anche nei colori laccati a campionario. Il piano è realizzato in nobilitato e può essere personalizzato con l'integrazione nei riquadri degli inserti disponibili nelle finiture laccate o con vetro Serigrafato o Extra Chiaro.

Exclusivity and high personalization are the prerogatives of Otis coffee tables. The base is in Bronzo Vintage lacquered metal, also available in lacquered colours. The top is made of melamine and can be personalized with the integration in the panels of the inserts available in the lacquered finishes or with Screen-printed or Extra Clear glass.

L'exclusivité et la haute personnalisation sont les prérogatives des tables basses Otis. La base est en métal peint en Bronzo Vintage, également disponible en couleurs laquées de la gamme. Le plateau est en melamine et peut être personnalisé grâce à l'intégration d'inserts disponibles dans des finitions laquées ou avec du verre Sérigraphié ou Extra Clair.

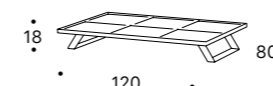
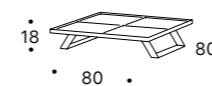



Beverly

Design Angelo Armano



Tavolino Beverly

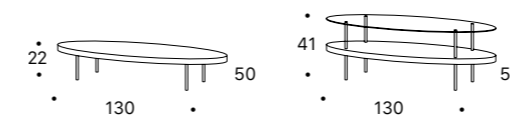

Un'elegante forma ovale ben definita con un richiamo al gusto classico, disponibile anche nella versione con il doppio piano, di cui uno in vetro. I piedi sono in metallo verniciato Bronzo Vintage, disponibili anche nei colori laccati a campionario. Il piano è in legno nelle finiture Rovere Cenere, Canaletto, Noce Naturale o laccato nei colori a campionario. Il piano in vetro è disponibile nei colori Extra Chiaro e Grigio Fumé.

An elegant, well-defined oval shape with a reference to classic taste, also available in the version with double top. The feet are in Bronzo Vintage painted metal, available in lacquered colours from sample collections. The top is in wood in Rovere Cenere, Canaletto, Noce Naturale finishes or lacquered in the various colours available. The glass top is available in Extra Clear and Gray Smoked colours.

Une forme ovale élégante qui fait référence au goût classique, aussi disponible dans la version avec le deuxième plateau en verre. Les pieds sont en métal verni Bronzo Vintage, également disponible en couleurs laquées. Le plateau est en bois de Rovere Cenere, Canaletto, Noce Naturale ou laqué dans des couleurs de la gamme. Le plateau en verre est disponible dans les couleurs Extra Clair et Gris Fumé.



Leonard

Design Angelo Armano



Tavolino Leonard

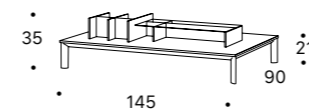

Leonard è un tavolino da salotto dal design esclusivo realizzato completamente in legno nelle finiture Rovere Cenere, Canaletto o Noce Naturale. Un elegante elemento, con diversi scompartimenti e vani per libri e oggetti dotato di piano d'appoggio in vetro con finitura Extra Chiaro, completa il look sofisticato di Leonard.

Coffee table with exclusive design made entirely in wood Rovere Cenere, Canaletto or Noce Naturale finishes. An elegant and practical element with compartments for books and objects with a glass top completes Leonard's sophisticated look. It comes standard with the glass shelf in an Extra Clear finish.

Table basse au design exclusif, entièrement en bois, dans les finitions Rovere Cenere, Canaletto ou Noce Naturale. Un élément élégant et pratique avec des compartiments pour les livres et les objets avec un plateau en verre complète le look sophistiqué de Leonard. Il est livré en standard avec l'étagère en verre dans une finition Extra Clair.

Alma PAG. 94



Madie

Beverly PAG. 114



Lexia PAG. 102



Kristen PAG. 108



Minimal PAG. 120

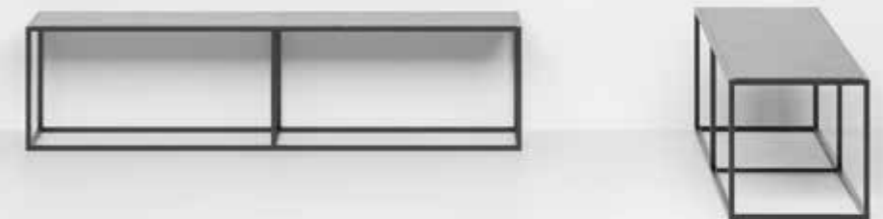



Alma

Design Angelo Armano



Madia Alma

Le forme geometriche della madia Alma sono definite dalle sue ante realizzate con un riquadro il cui interno può essere personalizzato con l'applicazione di inserti, disponibili in vari materiali, quali vetro serigrafato, elementi laccati o carta da parati. Il basamento in metallo prosegue lungo tutto il perimetro della madia, creando un look esclusivo di materiali e colori.

The geometric shapes of Alma sideboard are defined by its doors made with a square whose interior can be customized with the application of inserts available in various materials, such as screen-printed glass, lacquered elements or wallpaper. The metal base continues along the entire perimeter of the sideboard, creating an exclusive look.

Les formes géométriques du buffet Alma sont définies par ses portes réalisées avec un carré dont l'intérieur peut être personnalisé avec l'application d'inserts disponibles dans différents matériaux, tels que le verre sérigraphié, les éléments laqués ou le papier peint. Le socle métallique se poursuit sur tout le périmètre du buffet, créant un jeu exclusif de matériaux et de couleurs.



La sua forma ben definita può essere spezzata e personalizzata con l'inserimento di un telaio applicato sul fianco e sulla parte superiore della madia. Alma permette di personalizzare sia i colori laccati delle strutture telaio che gli inserti delle ante, creando un gioco cromatico che rende ogni pezzo unico.

Its well-defined shape can be broken and customized by inserting a frame that is applied to the side and top of the sideboard. Alma allows you to customise both the lacquered colours of the frame structures and the door inserts, creating a chromatic game that makes each piece unique.



Sa forme bien définie peut être brisée et personnalisée en insérant un cadre qui est appliqué sur le côté et sur le dessus du buffet. Alma vous permet de personnaliser soit les couleurs laquées des structures soit des inserts de la porte, créant ainsi un jeu chromatique qui rend chaque pièce unique.





Alma

Alma è una collezione di madie disponibile in sei varianti nelle versioni lineare o con il telaio metallico.

Finitura struttura: nobilitato India, Asia, Spatolato o Terra.

Finitura inserti ante: Vetro serigrafato, carta da parati nelle varianti Losanga, Rombo e Cemento o pannello laccato in 24 colori.

Finitura piedi e telaio: Bronzo Vintage di serie, optional laccato in 24 finiture colore.

Tablette materiali e finiture colore pagina 218

Alma is a collection of sideboards available in six versions, linear or with metal frame.

Structure finish: melamine India, Asia, Spatolato or Terra.

Finish of door inserts: Silkscreen printed glass, wallpaper in Losanga, Rombi and Cemento or lacquered panel in 24 colour variations.

Feet and frame finish: Bronzo Vintage as standard, optional lacquered in 24 colour finishes.

Material tables and colour finishes page 218

Alma est une collection de buffets disponible en six variantes en version linéaire ou à cadre métallique.

Finition de la structure: melamine India, Asia, Spatolato ou Terra.

Finition de l'insert de la porte: verre sérigraphié, papier peint en Losanga, Rombo et Cemento ou panneau laqué en 24 couleurs.

Finition du pied et du cadre: Bronzo Vintage en standard, en option laqué en 24 couleurs.

Tableaux des matériaux et des couleurs page 218

Alma - versione lineare / linear / linéaire

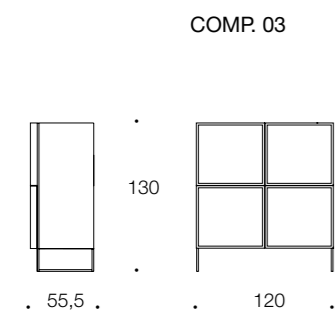
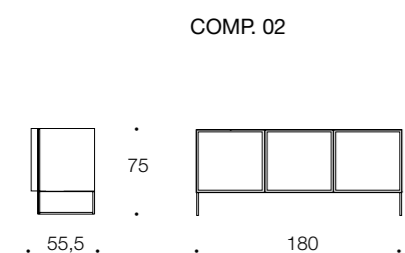
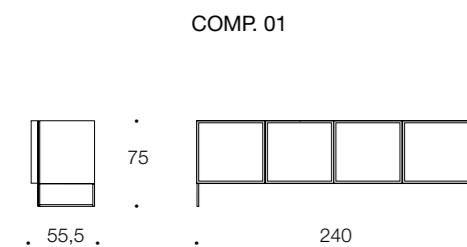

Alma - versione con telaio metallico / with metal frame / à cadre métallique

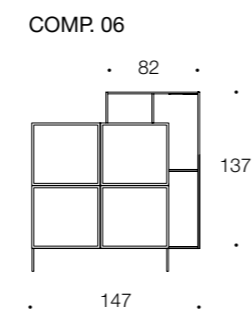
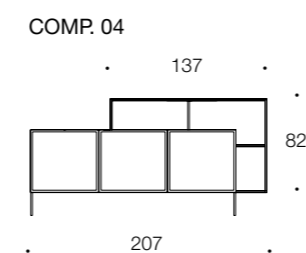
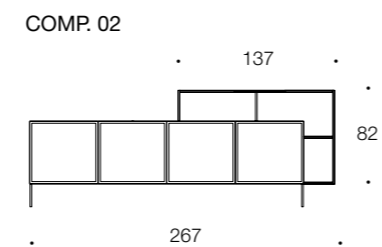
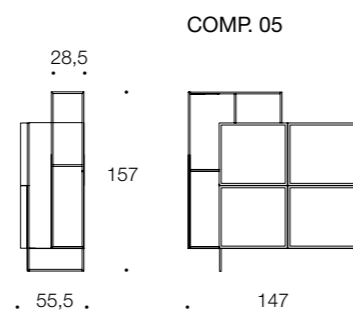
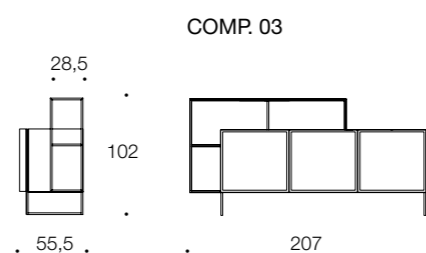
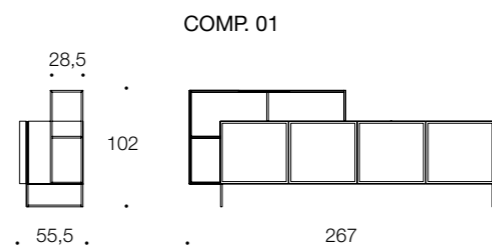



Lexia

Design Angelo Armano



Madia Lexia

Un programma di mobili contenitori disponibili nelle soluzioni a madia o libreria, entrambe con la possibilità di essere richieste nella versione con piede o sospesa. La linea pulita ed essenziale di Lexia è interrotta da vani a giorno che permettono di personalizzarla giocando con le diverse finiture cromatiche.

A range of storage units available as sideboard or bookcase solutions, both with the possibility to be requested with feet or in the suspended version. The clean and essential line of Lexia is interrupted by open compartments that allow you to personalise it with the different colour finishes.

Une gamme de meubles de rangement disponibles en version buffet ou bibliothèque, avec la possibilité de les demander en version sur pied ou suspendue. La ligne épurée et essentielle de Lexia est interrompue par des compartiments ouverts qui permettent de la personnaliser avec les différentes finitions de couleur.



La versatilità di Lexia si esprime sia per le diverse soluzioni di composizioni, sia per la possibilità di coordinare i colori dei contenitori con i telai a giorno. Inoltre la collezione delle madie Lexia permette di scegliere, a seconda delle diverse esigenze abitative, l'opzione tradizionale a terra con i piedi o la versione più leggera sospesa che può essere posizionata all'altezza desiderata.

The versatility of Lexia is expressed both by the different compositions available and by the possibility of coordinating the colours of the units with the open frames. In addition, the collection makes it possible to choose the traditional floor-standing option with feet or the lighter suspended version according to the taste and the different living needs.

La polyvalence du Lexia s'exprime à la fois par les différentes solutions de composition et par la possibilité de coordonner les couleurs des éléments avec les cadres ouverts. En outre, la collection permet de choisir l'option traditionnelle au sol avec des pieds ou la version suspendue plus légère selon les goûts et les différents besoins d'habitation.



Lexia

Lexia è una collezione di madie disponibile in cinque varianti nella versione orizzontale e due varianti nella versione verticale, con piedi o sospesa a parete.

Finiture struttura: in nobilitato India, Asia, Spatolato o Terra, oppure laccato nei 24 colori a campionario.

Finitura telai: laccato in 24 varianti colore.

Finitura piedi: Bronzo Vintage.

Lexia is a collection of sideboards available in five variants in the horizontal version and two variants in the vertical version, with feet or hanging on the wall.

Structure finish: melamine India, Asia, Spatolato, Terra or lacquered in 24 sample colours.

Frame finish: lacquered in 24 colours.

Feet finish: Bronzo Vintage.

Lexia est une collection de buffets disponible en cinq variantes dans la version horizontale et deux variantes dans la version verticale, avec des pieds ou accroché au mur.

Finition de la structure: melamine India, Asia, Spatolato, Terra ou laqué en 24 différents couleurs.

Finition des cadres: laqué en 24 couleurs.

Finition du pied: Bronzo Vintage.

Tabella materiali e finiture colore pagina 218

Material tables and colour finishes page 218

Tableaux des matériaux et des couleurs page 218

Lexia - versione con piedi / version with feet / version avec pieds

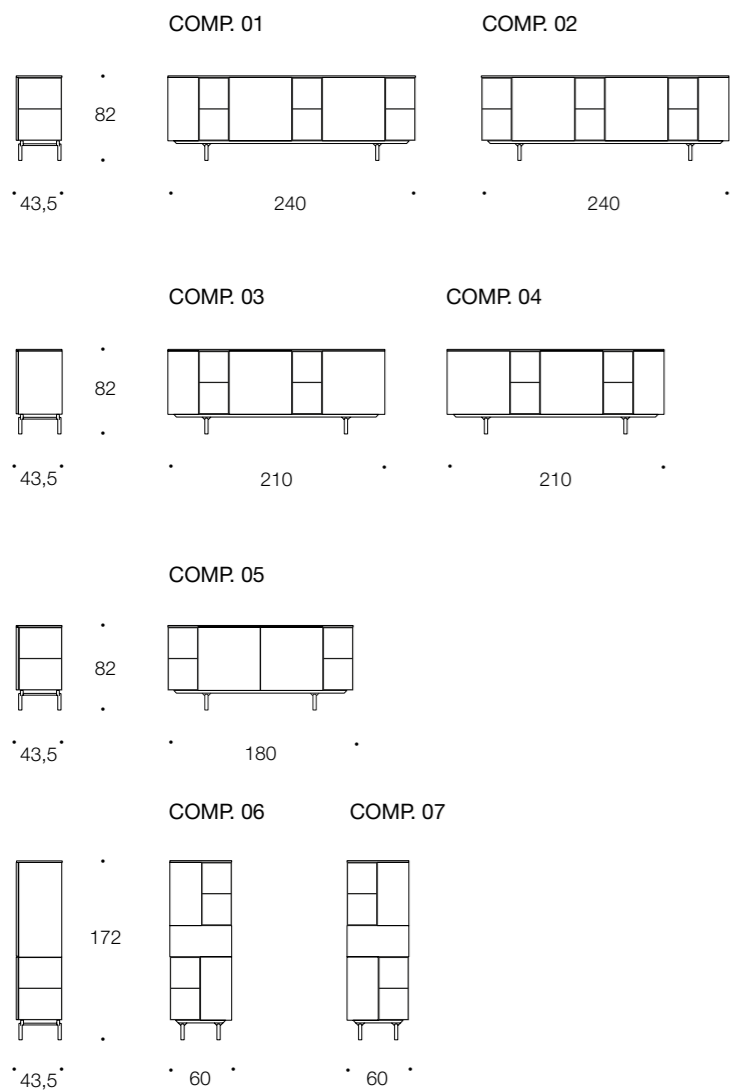

Lexia - versione sospesa / suspended version / version suspendue

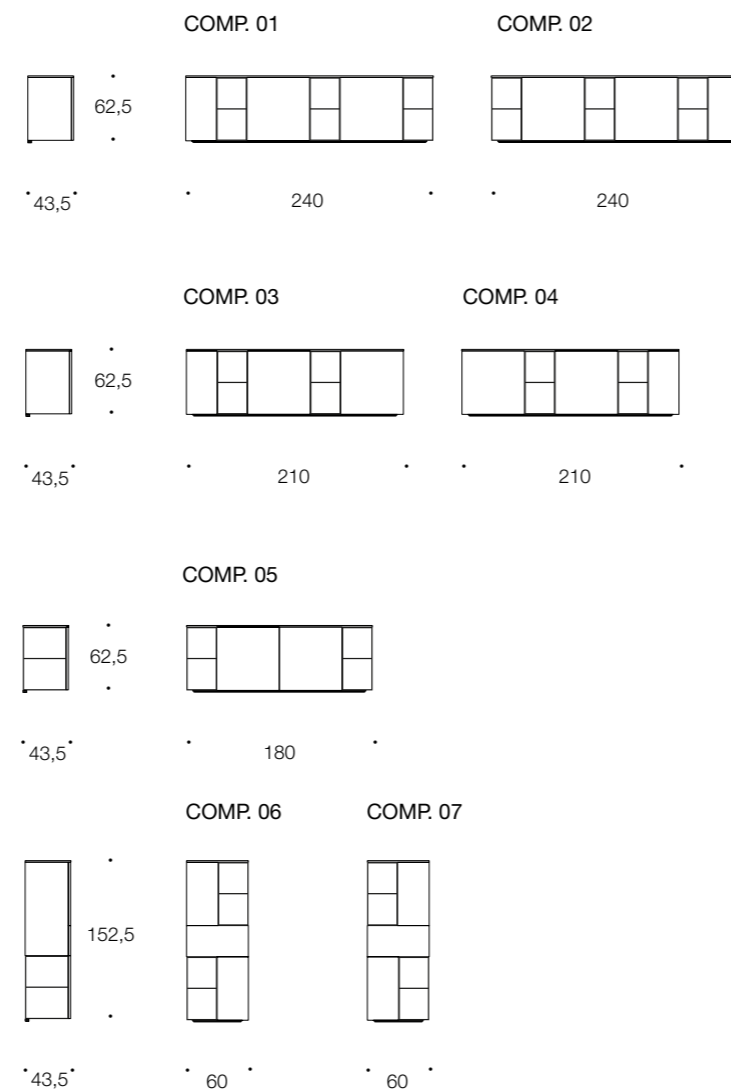



Kristen

Design Angelo Armano



Madia kristen

Linee marcate e ben definite da forme squadrate. La collezione propone madie lineari con sviluppo orizzontale o verticale. I riquadri che caratterizzano l'estetica della madia Kristen possono essere personalizzati con l'applicazione di inserti, disponibili in vari materiali: vetro serigrafato, elementi laccati o carta da parati.

Marked and well defined lines with square shapes. The collection proposes linear sideboards with horizontal or vertical development. The squares that characterize the aesthetics of the Kristen sideboard can be customized with the application of inserts, available in various materials: screen-printed glass, lacquered elements or wallpaper.

Des lignes marquées et bien définies avec des formes carrées. La collection propose des buffets linéaires avec un développement horizontal ou vertical. Les carrés qui caractérisent l'esthétique des buffets Kristen peuvent être personnalisés grâce à l'application d'inserts, disponibles en différents matériaux: verre sérigraphié, éléments laqués ou papier peint.



Le innumerevoli personalizzazioni della madia Kristen, permettono di realizzare soluzioni diverse con giochi di colori e materiali che rispondono alle varie esigenze abitative. Gli inserti in metallo dei vani a giorno si possono richiedere nei colori laccati disponibili a campionario. Le ante possono essere personalizzate anche con l'inserimento della carta da parati.

The countless customizations of the Kristen sideboard, allow to realize different solutions with games of colors and materials that meet the various housing needs. The metal inserts of the open compartments can be requested in the lacquered colours available in the range. The doors can also be customized by inserting wallpaper of various finishes.

Les innombrables personnalisations du Kristen, permettent de réaliser différentes solutions qui répondent aux différents besoins. Les inserts métalliques des compartiments ouverts peuvent être demandés dans les couleurs laquées disponibles dans la gamme. Les portes peuvent également être personnalisées en insérant du papier peint en différentes finitions.



Kristen

Kristen è una collezione di madie disponibile in versione lineare o versione verticale, entrambe con l'inserimento di vani a giorno.

Finitura struttura: nobilitato India, Asia, Spatolato, Terra.

Finitura inserti ante: vetro serigrafato, carta da parati nelle varianti Losanga, Rombo e Cemento o pannello laccato in 24 varianti colore. Gli elementi in metallo presenti nei vani a giorno sono realizzati di serie in Bronzo Vintage, optional possono essere richiesti nei vari colori laccati.

Finitura piedi: in metallo verniciato Bronzo Vintage.

Kristen is a collection of sideboards available in linear or vertical version, both with open compartments.

Structure finish: melamine India, Asia, Spatolato, Terra.

Door insert finish: silkscreen printed glass, wallpaper in Losanga, Rombo and Cemento or lacquered panel in 24 different colours. The metal elements in the standard open compartments are made in Bronzo Vintage finish, optional can be requested in the various lacquered colours.

Feet finish: in Bronzo Vintage painted metal.

Kristen est une collection de buffets disponible en version linéaire ou verticale, toutes deux à compartiments ouverts.

Finition de la structure: melamine India, Asia, Spatolato, Terra.

Finition de l'insert de porte: verre sérigraphié, papier peint en Losanga, Rombo et Cemento ou panneau laqué en 24 variantes de couleur. Les éléments métalliques présents dans les compartiments ouverts sont en Bronzo Vintage, en option, ils peuvent être demandés laqué en 24 variantes de couleur.

Finition du pied: en métal peint en Bronzo Vintage.

Tablelle materiali e finiture colore pagina 218

Material tables and colour finishes page 218

Tableaux des matériaux et des couleurs page 218

Kristen

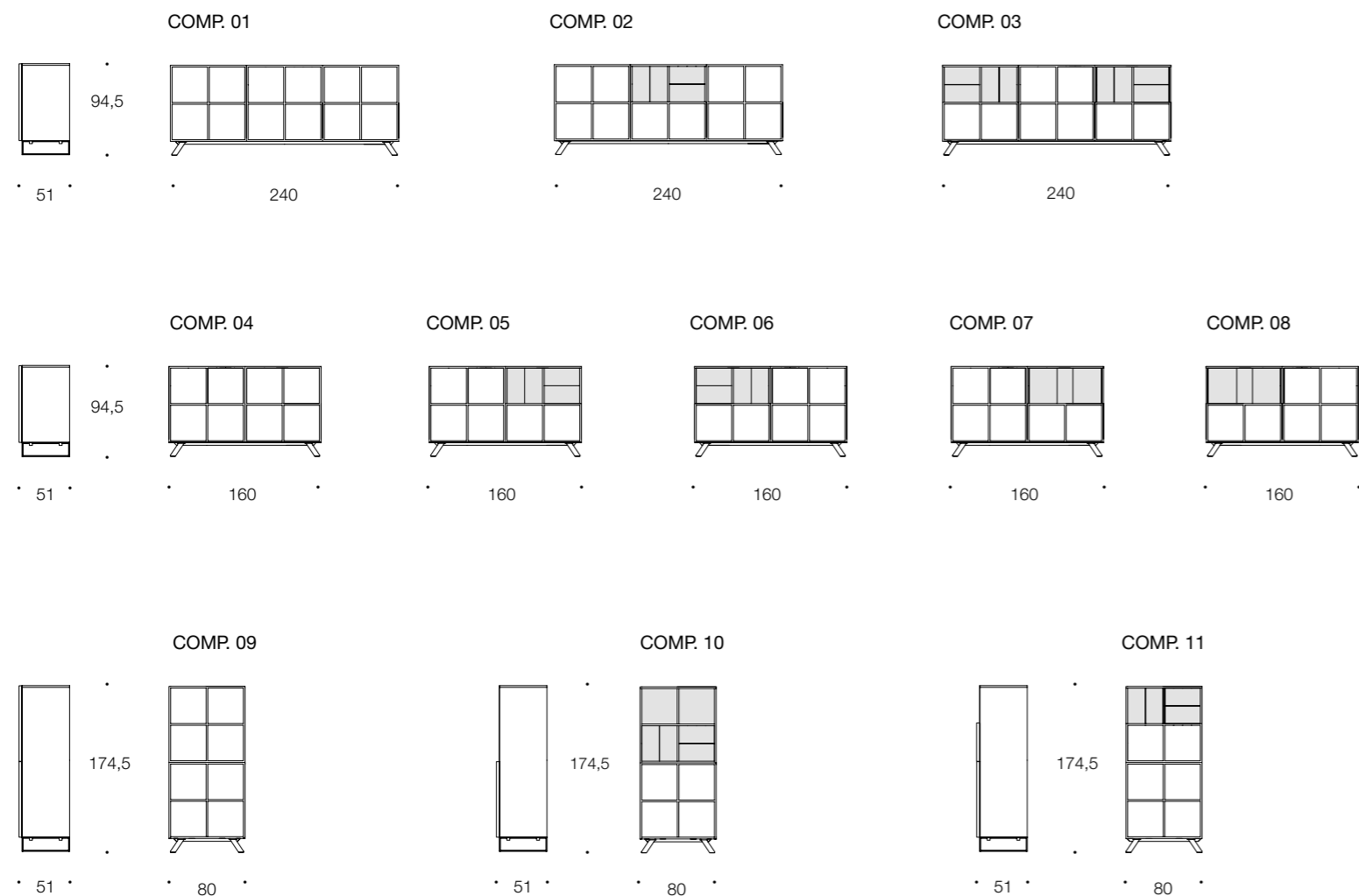



Beverly

Design Angelo Armano



Madia Beverly

Morbide forme ovali racchiudono la raffinatezza degli elementi Beverly. Programma composto da una madia, una consolle e una libreria. Piccoli dettagli, come la maniglia in metallo incassata e il leggero piede cilindrico realizzati dello stesso colore, sono elementi che rendono Beverly una madia votata all'esclusività e all'eleganza.

Soft oval shapes enclose the refinement of the Beverly elements. Program composed of a sideboard, a console and a bookcase. Small details, such as the recessed metal handle and the light cylindrical feet that are made of the same colour, are elements that make Beverly a sideboard devoted to exclusivity and elegance.

Des formes ovales douces renferment le raffinement des éléments de Beverly. Programme composé d'un buffet, d'une consolle et d'une bibliothèque. De petits détails, tels que la poignée métallique encastrée et le pied cylindrique léger de la même couleur, sont des éléments qui font de Beverly un buffet voué à l'exclusivité et à l'élégance.



Beverly nella versione laccata con vetro Fumé esprime la massima raffinatezza rendendo la madia un elemento d'arredo esclusivo. La Libreria e la consolle sono elementi complementari che con la loro leggerezza costruttiva permettono di essere inseriti facilmente nei vari contesti abitativi.

Beverly in the lacquered version with Smoked glass expresses the maximum refinement making the sideboard an exclusive furnishing element. The bookcase and the console are complementary elements that with their lightness of construction allow to be easily placed in various living contexts.

Beverly dans la version laquée avec du verre Fumé exprime le maximum de raffinement en faisant du buffet un élément d'ameublement exclusif. La bibliothèque et la console sont des éléments complémentaires qui, grâce à leur légèreté de construction, permettent de les insérer facilement dans différents contextes de la maison.

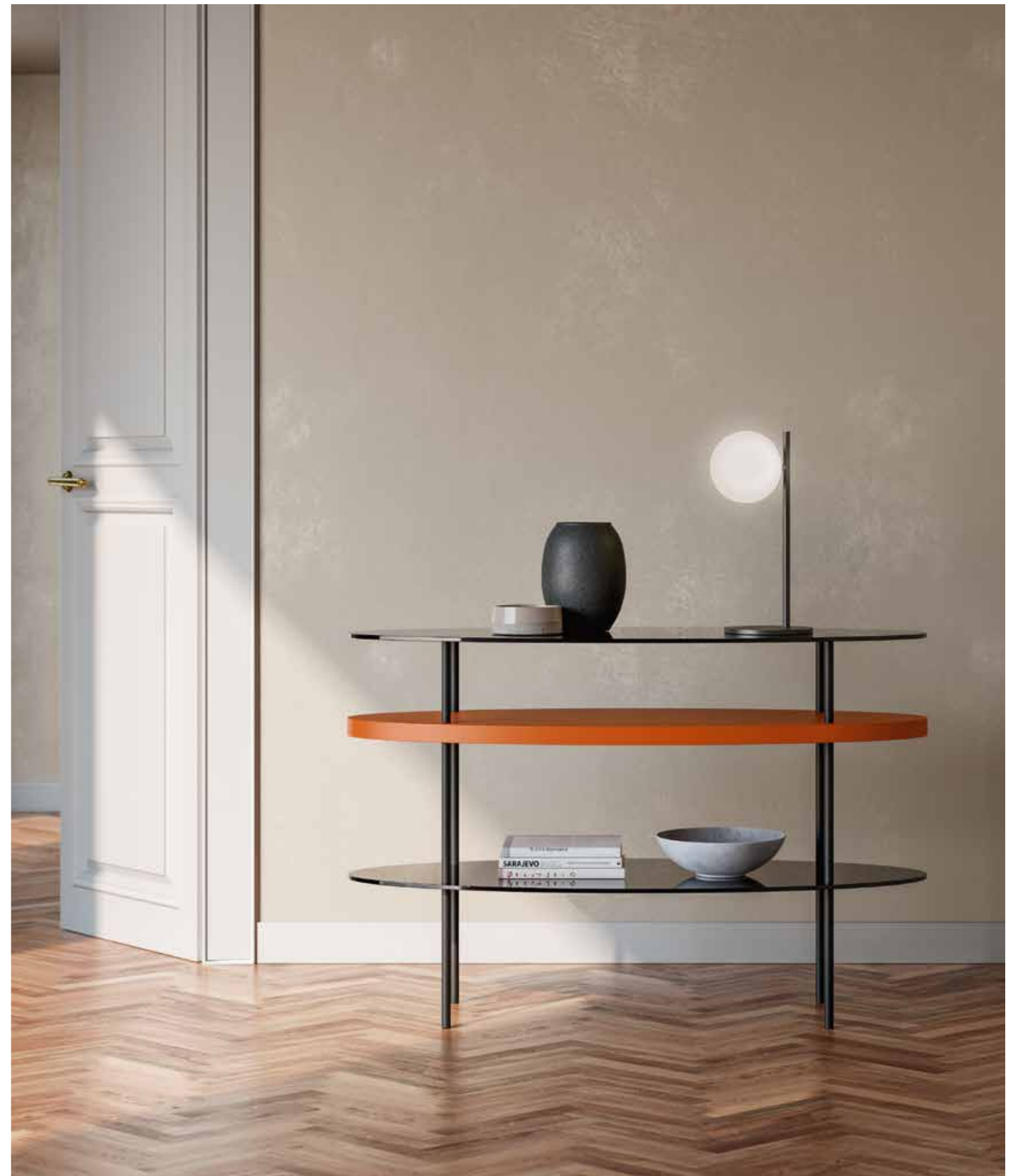

Beverly

Beverly è una collezione composta da una madia, una consolle e una libreria.

Finitura struttura: in legno nelle finiture Noce Naturale, Canaletto e Rovere Cenere, o in laccato nei colori a campionario.

Finitura piani in vetro: Vetro Extra Chiaro, optional disponibile in grigio Fumé.

Finitura piedi, telai e maniglia: in metallo verniciato Bronzo Vintage di serie, optional nei vari colori laccati.

Beverly is a collection consisting of a sideboard, a console and a bookcase.

Structure finish: in wood in the finishes Noce Naturale, Canaletto and Rovere Cenere, or lacquer in the colours of the range.

Glass tops finish: Extra Clear glass, optional available in Smoked grey.

Feet, frames and handle finish: in Bronzo Vintage painted metal as standard, optional in the various lacquered colours.

Beverly est une collection composée d'un buffet, d'une console et d'une bibliothèque.

Finition de la structure: en bois dans les finitions Noce Naturale, Canaletto et Rovere Cenere, ou en laque dans les différents couleurs de la gamme.

Finition des plateaux en verre: verre Extra Clair, disponible en option en gris Fumé.

Finition des pieds, des cadres et des poignées: en métal peint Bronzo Vintage ou en option dans les couleurs laquées.

Table materials and finishes page 218

Material tables and colour finishes page 218

Tableaux des matériaux et des couleurs page 218

Beverly

MADIA

CONSOLE

LIBRERIA

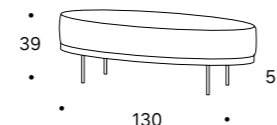
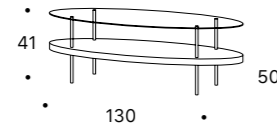
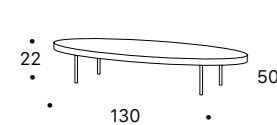
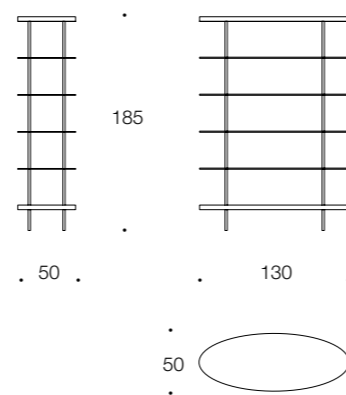
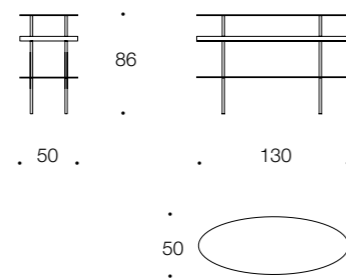
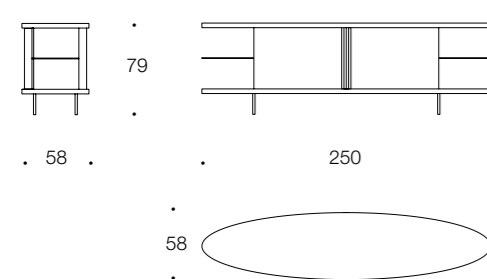

La madia, la consolle e la libreria Beverly sono abbinabili e coordinati con i tavolini e il pouf della stessa collezione.

The Beverly sideboard, console and bookcase can be combined and coordinated with the coffee tables and the ottoman from the same collection.

Le buffet, la console et la bibliothèque Beverly peuvent être combinés et coordonnés avec les tables basses et le pouf de la même collection.





Minimal

Design D.S. Studio



Madia Minimal

Un elemento di arredo dalle linee essenziali che facilmente si contestualizza in tutti gli ambienti dai più ricercati ai più tradizionali. Minimal è realizzata con un telaio in metallo a sezione quadrata e un piano che può essere richiesto nelle finiture nobilitato, laccato o in pietra Gray Stone.

A furniture element with essential lines that easily contextualises in all environments from the most refined to the most traditional. Minimal is made with a square section metal frame and a top that can be requested in melamine, lacquered or Gray Stone finishes.

Un meuble aux lignes essentielles qui se contextualise facilement tous les environnements des plus raffinés aux plus traditionnels. Minimal est réalisé avec une structure en métal de section carrée et un plateau qui peut être demandé en mélamine, laque ou en pierre Gray Stone.

Minimal

Minimal è una panca, console multifunzione disponibile in un'unica misura.

Finitura telaio: in metallo a sezione quadra 2x2 cm verniciato Bronzo Vintage.

Finitura piano: nobilitato nelle finiture Asia, India, Terra, Spatolato o nei colori laccati a campionario con piano intero oppure in pietra Gray Stone con piano composto da due lastre.

Minimal is a bench, multifunction console available in one size.

Frame finish: in 2x2 cm square section metal painted Bronzo Vintage.

Top finish: melamine in Asia, India, Terra, Spatolato or the lacquered colours of the range finishes with a single top. Also available in Gray Stone with top divided into two slabs.

Minimal est un banc, une console multifonctionnelle disponible en une seule taille.

Finition du cadre: en métal de section carrée 2x2 cm peint en Bronzo Vintage.

Finition du plateau: melamine Asia, India, Terra, Spatolato ou dans les couleurs laquées de la gamme avec un seul sommet. Également disponible en pierre Gray Stone avec le dessus divisé en deux dalles.

Tabella materiali e finiture colore pagina 218

Material tables and colour finishes page 218

Tableaux des matériaux et des couleurs page 218

Minimal

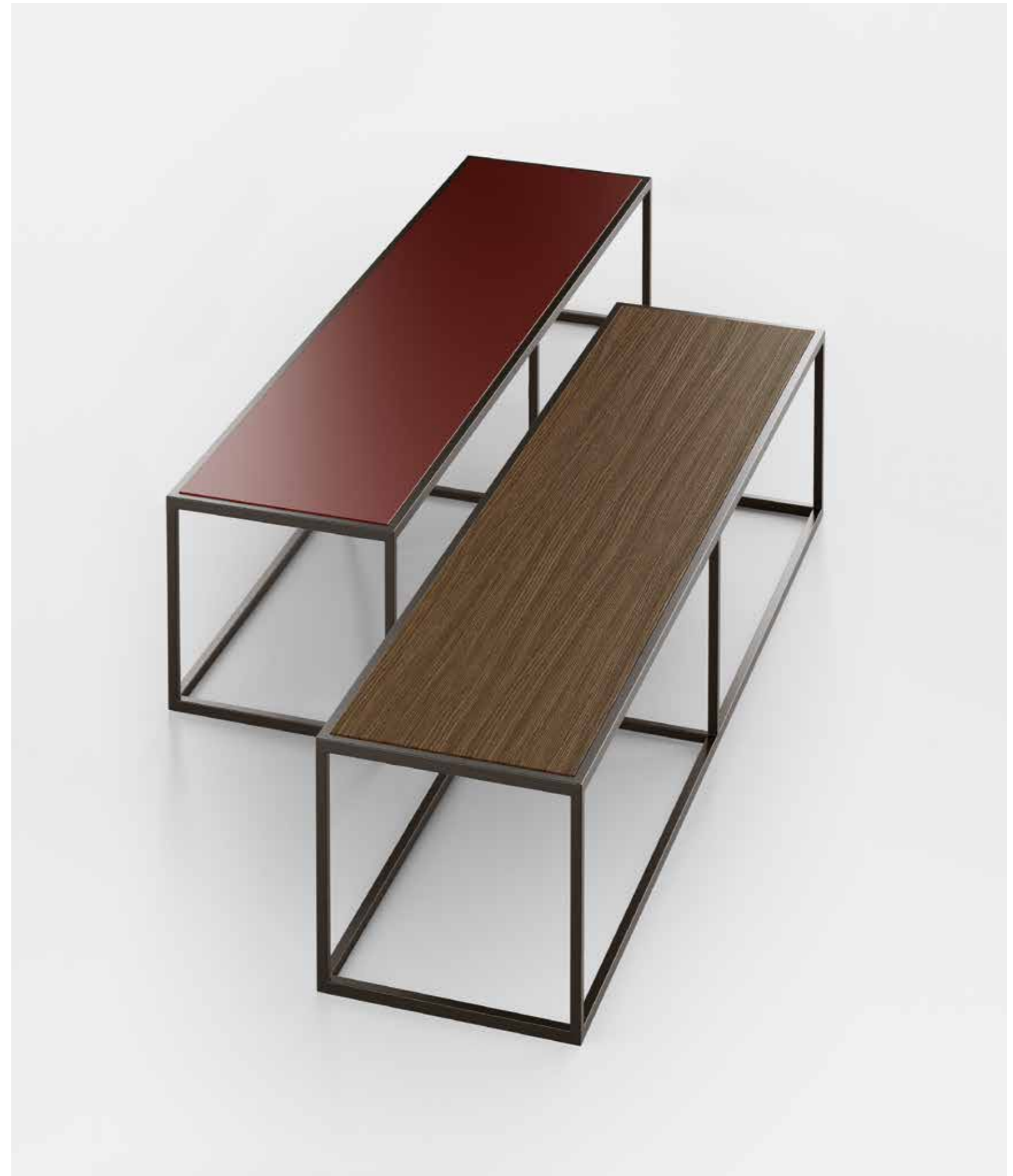
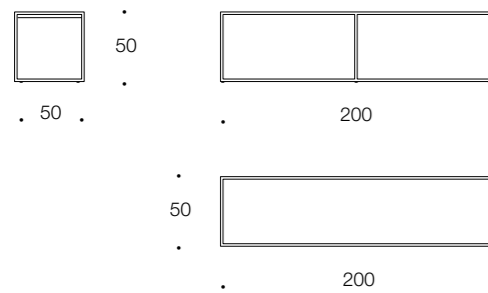

Librerie



Beverly PAG. 136

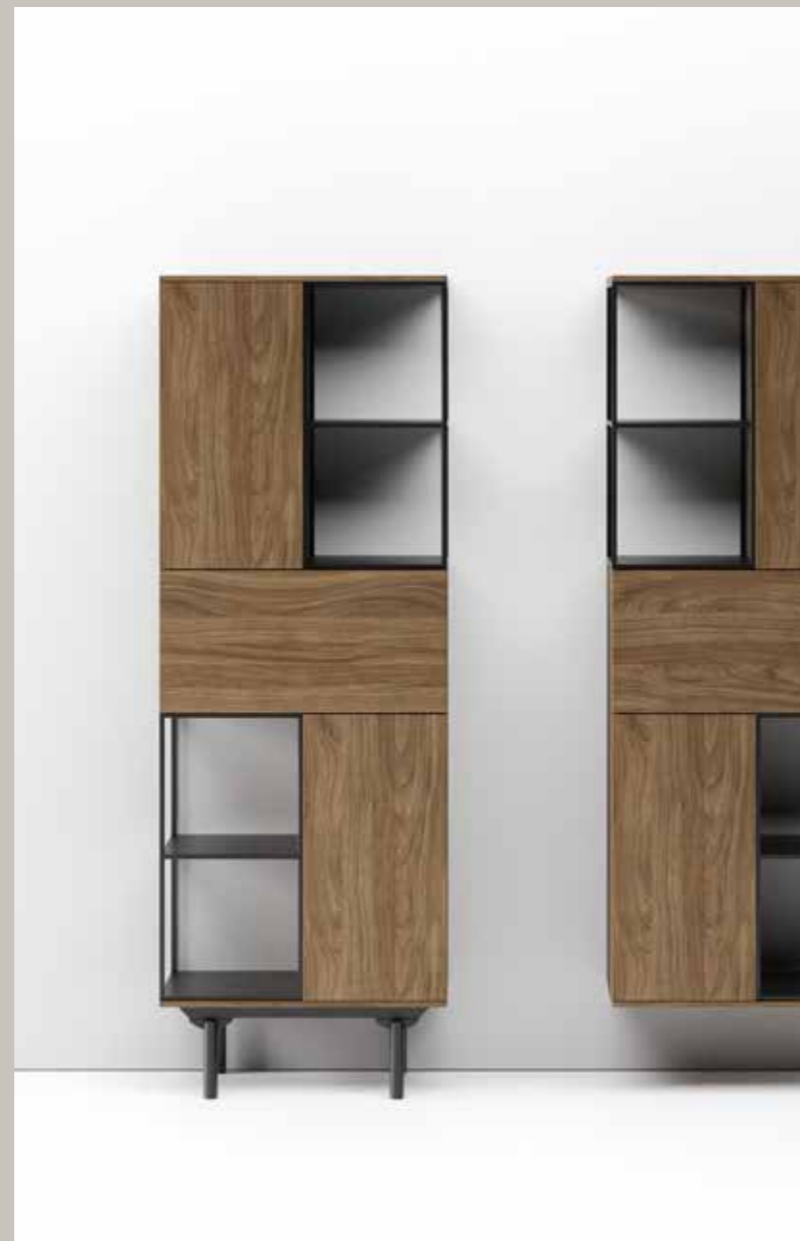

Lexia PAG. 132



Swing PAG. 126



Swing

Design D.S. Studio

Linee sinuose che si intervallano tra loro creando un raffinato movimento. Elementi di due misure e in due soluzioni, a parete o centro stanza, che si compongono tra loro per rispondere a qualsiasi esigenza di spazio e disposizione. La libreria Swing può essere realizzata in nobilitato o nei colori laccati a campionario.

Sinuous lines interspersed with each other creating a refined movement. Elements of two sizes and in two solutions, on the wall or in the middle of the room, which are composed of each other to meet any need for space and layout. The Swing bookcase can be made in melamine or in lacquered colours.

Des lignes sinueuses s'intercalent entre elles, créant un mouvement raffiné. Des éléments de deux tailles et en deux solutions, au mur ou au milieu de la pièce, qui se composent l'un de l'autre pour répondre à tout besoin d'espace et d'aménagement. La bibliothèque Swing peut être réalisée en mélamine ou en couleurs laquées.



La libreria Swing è disponibile nella versione a parete con il fissaggio a muro o nella versione centro stanza con il fissaggio a soffitto tramite dei pali telescopici. In entrambe le soluzioni si possono realizzare librerie con il modulo singolo da 90 e da 120 cm o delle composizioni utilizzando multipli della stessa misura.

The Swing bookcase is available in the wall version with wall fixing or in the room centre version with ceiling fixing by means of telescopic poles. In both solutions it is possible to create bookcases with a single module of 90 and 120 cm or compositions using multiples of the same size.

La bibliothèque Swing est disponible dans la version murale avec fixation au mur ou dans la version centre de la pièce avec fixation au plafond au moyen de poteaux télescopiques. Dans les deux solutions, il est possible de créer des bibliothèques avec un seul module de 90 et 120 cm ou des compositions utilisant des multiples de la même taille.



Swing

Swing è una libreria disponibile in due misure e due versioni da parete o da centro stanza. Grazie alla combinazione dei moduli terminali ed intermedi si possono sviluppare una serie di composizioni delle lunghezze desiderate.

Finitura struttura: realizzata in nobilitato Asia, India, Spatolato, Terra o Laccato nei 24 colori a campionario.

Pali telescopici: realizzati in metallo, verniciato Bronzo Vintage con le finiture nobilitate, mentre nella versione laccata prendono lo stesso colore della struttura.

Tablette materiali e finiture colore pagina 218

Swing is a bookcase available in two sizes and two wall or centre-room versions. Thanks to the combination of end and intermediate modules a series of compositions of the desired lengths can be developed.

Structure finish: melamine in Asia, India, Spatolato, Terra or lacquered in the various colours of the range.

Telescopic poles: made of metal painted Bronzo Vintage, with the ennobled finishes, while in the lacquered version they take the same colour as the structure.

Material tables and colour finishes page 218

Swing est une bibliothèque disponible en deux tailles et en deux versions: murale ou centrale. Grâce à la combinaison de modules finaux et intermédiaires, il est possible de développer une série de compositions de la longueur souhaitée.

Finition de la structure: melamine Asia, India, Spatolato, Terra ou laqué dans des couleurs de la gamme.

Poteaux télescopiques: en métal laqué Bronzo Vintage avec les finitions melamine, tandis que en version laquée prend la même couleur que la structure.

Tableaux des matériaux et des couleurs page 218

Swing

Versione da parete
Wall mounting
Montage mural

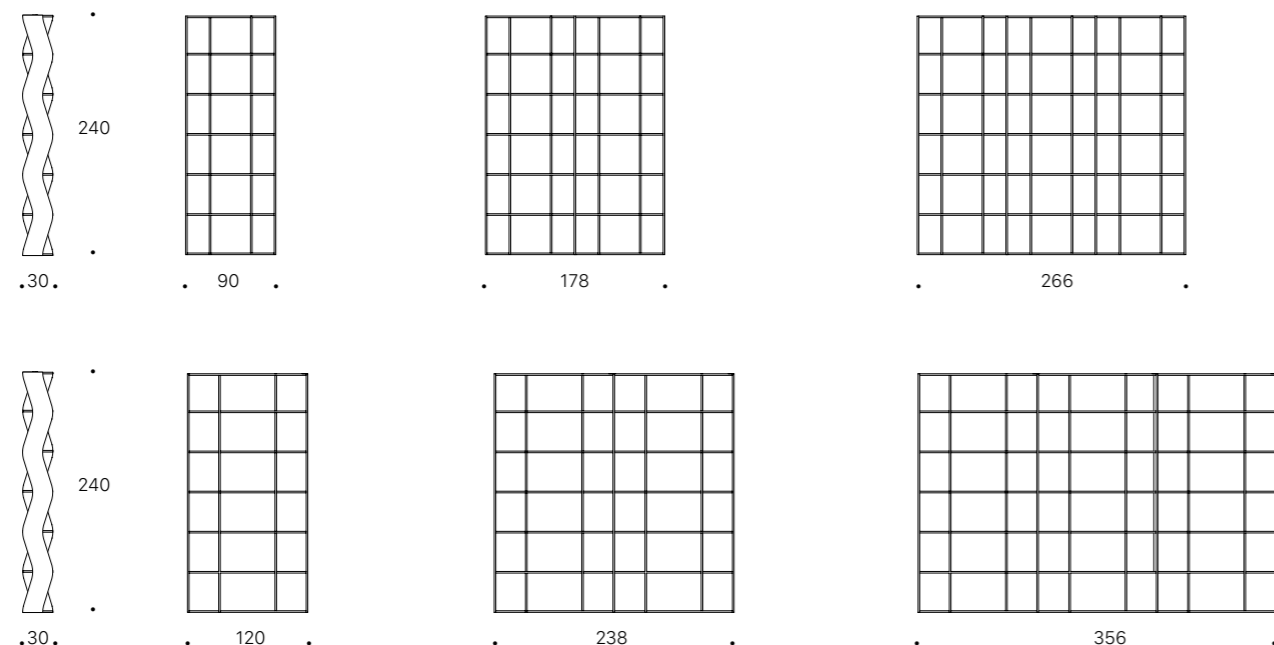

Swing

Versione centro stanza
Center-room version
Version centrale

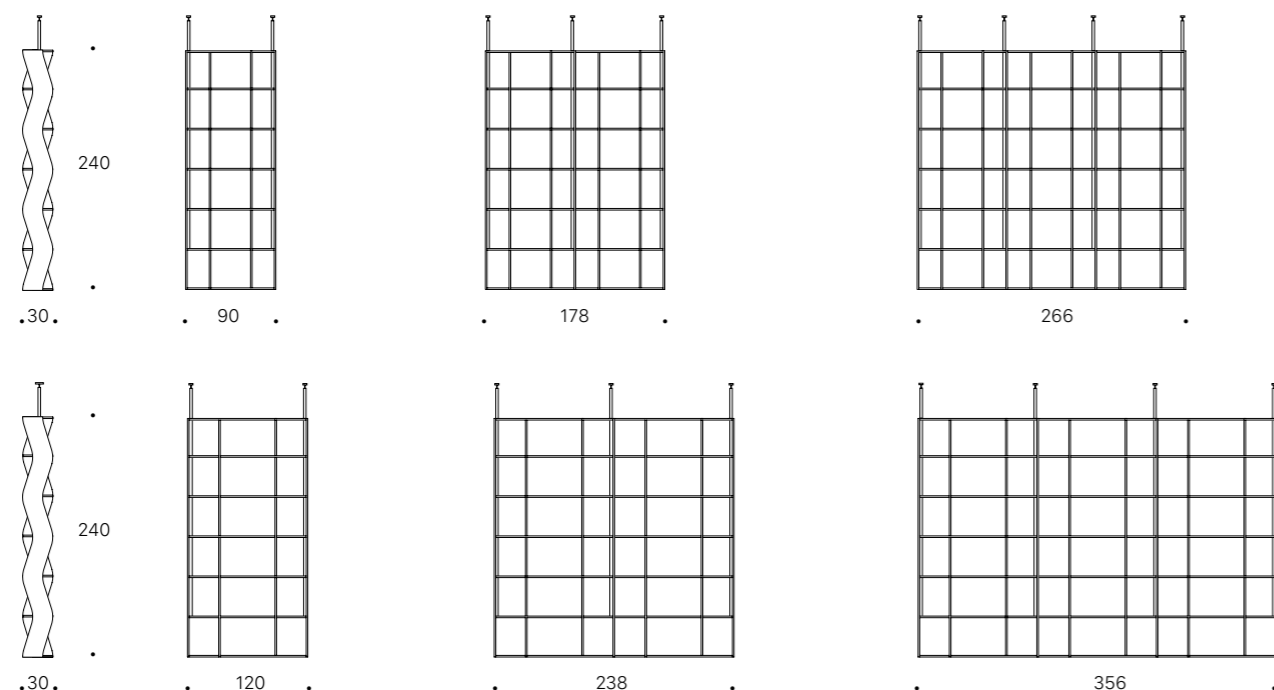



Lexia

Design Angelo Armano

Un gioco di elementi chiusi e aperti realizzati con materiali e colori diversi, sono le caratteristiche costruttive della libreria Lexia. Un elemento d'arredo unico che ben si contestualizza in ambienti moderni. Disponibile sia con piedi che senza, nella versione sospesa di possono creare dei giochi di movimento nella parete. Lexia può essere appesa all'altezza desiderata.

A game of closed and open elements made with different materials and colours is the construction feature of the Lexia bookcase. A unique furnishing element that is well contextualized in modern environments. Available with or without feet, in the suspended version they can create movement games in the wall. Lexia can be hung at the desired height.

Un jeu d'éléments fermés et ouverts réalisés avec différents matériaux et couleurs est la caractéristique de construction de la bibliothèque Lexia. Un élément d'ameublement unique qui est bien contextualisé dans les environnements modernes. Disponibles avec ou sans pieds, dans la version suspendue, ils peuvent créer des jeux de mouvement dans le mur. Lexia peut être suspendue à la hauteur souhaitée.

Lexia

Lexia libreria disponibile sia nella versione sospesa che a terra con piedi.

Finitura struttura: nobilitato India, Asia, Spatolato o Terra, o laccato nei 24 colori a campionario.

Finitura telai: laccato in 24 varianti colore.

Finitura piedi: in metallo verniciato Bronzo Vintage.

Lexia bookcase available in two versions: suspended or floor-standing with feet.

Structure finish: melamine India, Asia, Spatolato, Terra or lacquered in 24 sample colours.

Frame finish: lacquered in 24 colours.

Feet finish: Bronzo Vintage painted metal.

Lexia est disponible en deux versions: suspendue ou sur pieds.

Finition de la structure: melamine India, Asia, Spatolato, Terra ou laqué en 24 couleurs.

Finition des cadres: laqué en 24 couleurs.

Finition du pied: en métal peint en Bronzo Vintage.

Tabella materiali e finiture colore pagina 218

Material tables and colour finishes page 218

Tableaux des matériaux et des couleurs page 218

Lexia - versione con piedi / with feet / avec pieds

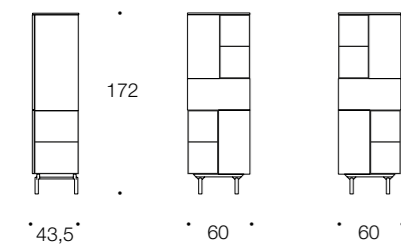

Lexia - versione sospesa / suspended / suspendue

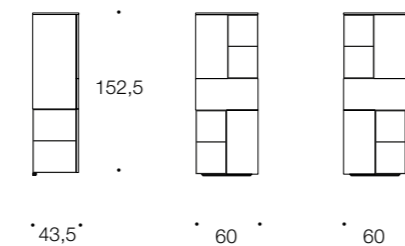

Beverly

Design Angelo Armano



Libreria dalle forme raffinate costituita da due elementi in legno e un leggero telaio che sorregge i vari ripiani in vetro, disponibili con la finitura Extra Chiaro o grigio Fumé. Perfetta anche in centro stanza come divisione tra un ambiente e l'altro. Una libreria adatta a contenere degli oggetti preziosi e da mettere in mostra.

Bookcase with refined shapes made up of two wooden elements and a light frame that supports the various glass shelves, available in Extra Clear or Smoked grey finish. Also perfect in the center of the room as a division between one room and another. A bookcase suitable to contain precious objects and to show off.

Bibliothèque aux formes raffinées composée de deux éléments en bois et d'un cadre léger qui supporte les différentes étagères en verre, disponible en finition Extra Clair ou gris Fumé. Parfait également au centre de la pièce comme séparation entre une pièce et une autre. Une bibliothèque adaptée pour contenir des objets précieux et les exposer.

Beverly

Beverly libreria disponibile in un'unica misura.

Finitura struttura: in legno nelle finiture Noce Naturale, Canaletto e Rovere Cenere oppure in laccato nei 24 colori a campionario.

Finitura piani in vetro: Vetro Extra Chiaro, optional disponibile in grigio Fumé.

Finitura piedi, telai: in metallo verniciato Bronzo Vintage di serie, optional nei vari colori laccati.

Tablelle materiali e finiture colore pagina 218

Beverly bookcase available in one size only.

Structure finish: in wood, in the finishes Noce Naturale, Canaletto and Rovere Cenere or in lacquered in the sample 24 colours.

Glass tops finish: Extra Clear glass, optional available in Smoked grey.

Finishing of the feet, frames: in Bronzo Vintage painted metal as standard, optional in the various lacquered colours.

Material tables and colour finishes page 218

Beverly est une bibliothèque disponible en taille unique.

Finition de la structure: en bois dans les finitions Noce Naturale, Canaletto et Rovere Cenere, en laqué dans les 24 couleurs.

Finition des top en verre: verre Extra Clair, disponible en option en gris Fumé.

Finition des pieds, cadres: en métal peint Bronzo Vintage, en option dans les différentes couleurs laquées.

Tableaux des matériaux et des couleurs page 218

Beverly

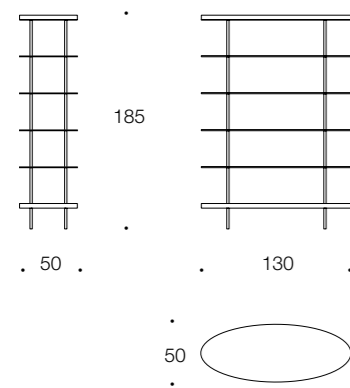



Melange PAG. 142



Geometrico PAG. 144

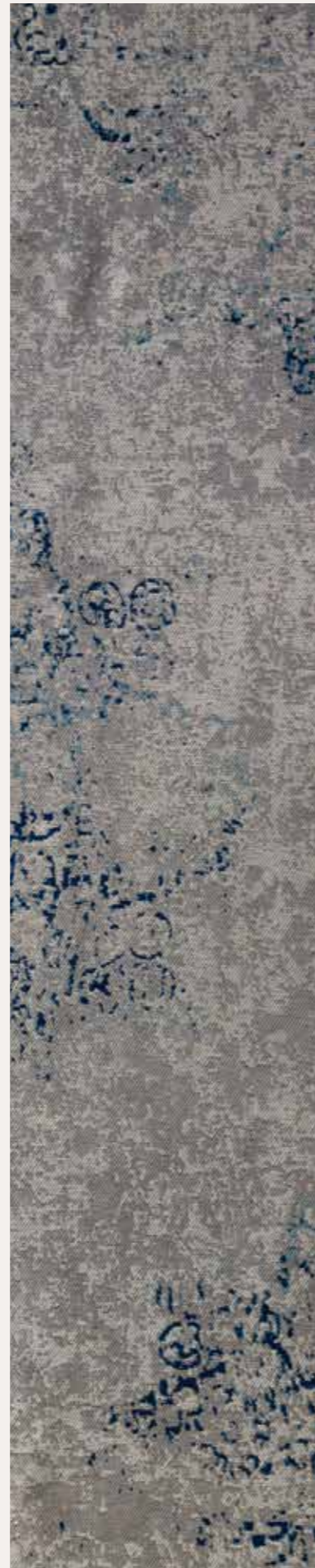

Vintage PAG. 146



Zigzag PAG. 148

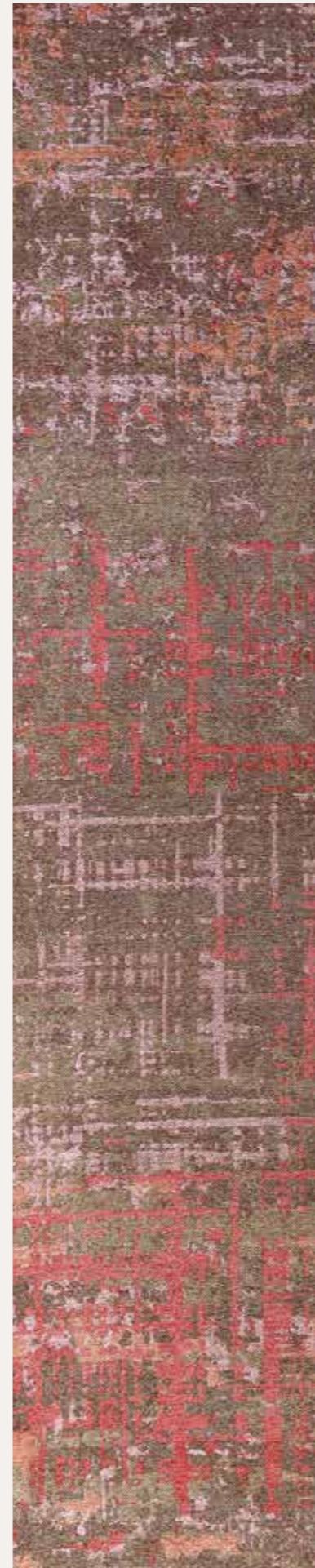

Fantasia PAG. 150



Trendy PAG. 152

Tappeti



Melange

Design D.S. Studio



Melange

Tappeto Melange Beige - Azzurro
160 x 230 cm
200 x 300 cm

Tappeto Melange Beige - Marrone
160 x 230 cm
200 x 300 cm

Un gioco di due colori che creano un'elegante e distinto effetto melange. Questo particolare disegno è abbinabile sia con un arredamento moderno che classico. Disponibile in due diverse misure e coordinabili facilmente anche con una tinta unita. La raffinatezza di questi pezzi personalizzano la stanza con un gusto unico. I tappeti sono realizzati in ciniglia di poliestere e cotone.

A game of two colours that create an elegant mixing effect. This particular design can be combined with both modern and classic furniture. Available in two different sizes and easily coordinated with a solid colour. The refinement of these pieces personalize the room with a unique taste. The rugs are made of polyester and cotton chenille.

Un jeu de deux couleurs qui créent un élégant effet de mélange. Ce design particulier peut être combiné avec des meubles modernes et classiques. Disponible en deux tailles différentes et facilement coordonnable avec une couleur unie. Le raffinement de ces pièces personnalise la pièce avec un goût unique. Les tapis sont fabriqués en chenille de polyester et coton.

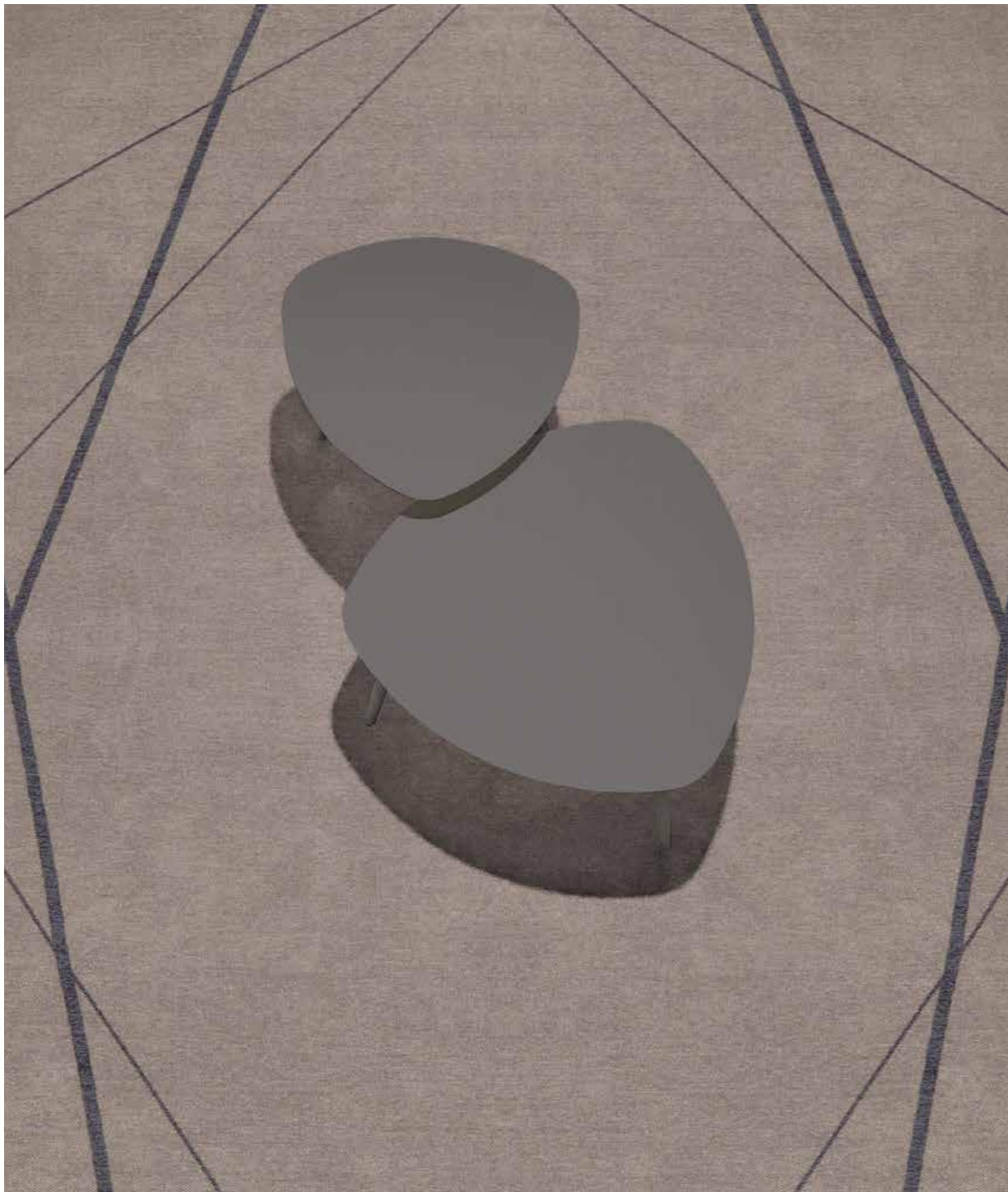

Geometrico

Design D.S. Studio

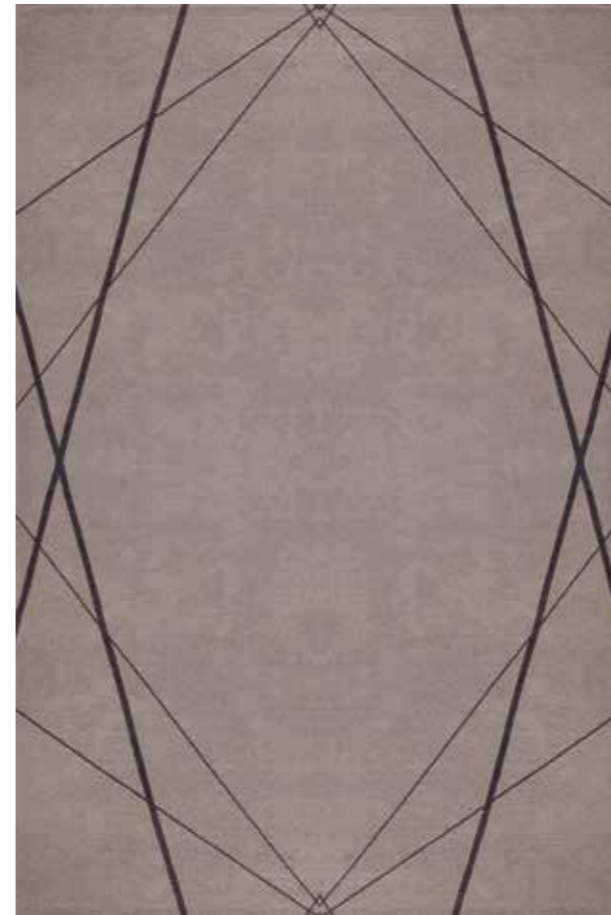

Geometrico

Tappeto Geometrico Grigio - Antracite
160 x 230 cm
200 x 300 cm

Tappeto Geometrico Tortora - Corallo
160 x 230 cm
200 x 300 cm

Linee che si intersecano creando un disegno geometrico ben definito, disponibile in due tonalità. Pulito, lineare, questo modello si sposa bene con un arredamento moderno o tradizionale. Disponibile in due diverse misure. I tappeti sono realizzati in ciniglia di poliestere e cotone.

Lines that intersect to create a well-defined geometric design, available in two shades. Clean, linear, this model goes well with modern or traditional furniture. Available in two different sizes. The rugs are made of polyester and cotton chenille.

Des lignes qui se croisent pour créer un dessin géométrique bien défini, disponible en deux teintes. Propre, linéaire, ce modèle se marie bien avec un mobilier moderne ou traditionnel. Disponible en deux tailles différentes. Les tapis sont fabriqués en chenille de polyester et coton.



Vintage

Design D.S. Studio



Vintage

Tappeto Vintage Grigio - Blu
160 x 230 cm
200 x 300 cm

Tappeto Vintage Grigio - Verde
160 x 230 cm
200 x 300 cm

Collezione di tappeti in due tonalità con effetto délavé. Questa linea neoclassica ben si sposa con arredamenti di tutti i tipi, dal moderno al classico, dal tradizionale al rustico, dal minimalista al design, dal bohemian al contemporaneo. I colori presenti in questa collezione sono riposanti e intramontabili. I tappeti sono realizzati in ciniglia di poliestere e cotone.

Collection of rugs in two shades with délavé effect. This neo-classical line goes well with furniture of all kinds, from modern to classic, from traditional to rustic, from minimalist to design, from bohemian to contemporary. The colours in this collection are restful and timeless. The rugs are made of polyester and cotton chenille.

Collection de tapis en deux tons avec effet délavé. Cette ligne néo-classique se marie bien avec tous les types de meubles, du moderne au classique, du traditionnel au rustique, du minimaliste au design, de la bohème au contemporain. Les couleurs de cette collection sont reposantes et intemporelles. Les tapis sont fabriqués en chenille de polyester et coton.



Zigzag

Design D.S. Studio

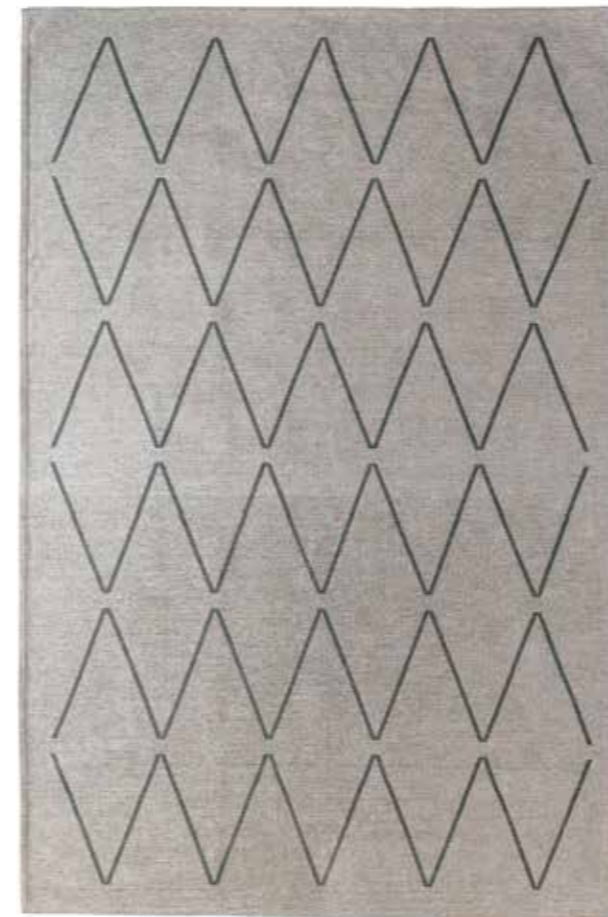

Zigzag

Tappeto Zigzag Beige - Antracite
160 x 230 cm
200 x 300 cm

Tappeto Zigzag Antracite - Beige
160 x 230 cm
200 x 300 cm

Un disegno a rombo ben definito in contrasto con il colore di base del tappeto crea un esclusivo gioco di bianco e nero. Dallo stile moderno e contemporaneo, sono tappeti che ben si sposano con i salotti di oggi, abbinati magari ad una tinta unita con una forte personalità. Disponibili in due diverse misure. I tappeti sono realizzati in cinghia di poliestere e cotone.

A well-defined rhombus pattern in contrast with the basic colour of the carpet creates an exclusive black and white play on the rug. Modern and contemporary in style, these rugs go well with today's living rooms, perhaps combined with a solid colour with a strong personality. Available in two different sizes. The rugs are made of polyester and cotton chenille.

Un motif en losange bien défini, en contraste avec la couleur de base du tapis, crée un jeu exclusif en noir et blanc sur le tapis. De style moderne et contemporain, ces tapis s'accordent bien avec les salons d'aujourd'hui, peut-être combinés avec une couleur unie à forte personnalité. Disponible en deux tailles différentes. Les tapis sont fabriqués en chenille de polyester et coton.



Fantasia

Design D.S. Studio



Fantasia

Tappeto Fantasia Rosa - Corallo
160 x 230 cm
200 x 300 cm

Colori pastello dalle tonalità rosate creano un elegante gioco di colori. Facile da abbinare grazie alle sue tonalità che ben si sposano con gran parte dei colori. Questa fantasia, accostabile a quasi tutti i tipi di legno è perfetta per un salotto dai colori caldi come il rosa, marrone, panna, bruciato, testa di moro o rosso. Disponibile in due diverse misure. Il tappeto è realizzato in ciniglia di poliestere e cotone.

Pastel colours in pink shades create an elegant game of colours. Easy to match thanks to its different shades that go well with most colours. This pattern, which can be combined with almost all types of wood, is perfect for a living room with warm colours such as pink, brown, cream, burnt, dark brown or red. Available in two different sizes. The carpet is made of polyester and cotton chenille.

Les couleurs pastel dans les tons de rose créent un élégant jeu de couleurs. Facile à assortir grâce à ses différentes nuances qui se marient bien avec la plupart des couleurs et presque tous les types de bois, est parfait pour une salle de séjour avec des couleurs chaudes comme le rose, le marron, le crème, le brûlé, ou le rouge. Disponible en deux tailles différentes. Le tapis est fait de chenille de polyester et coton.

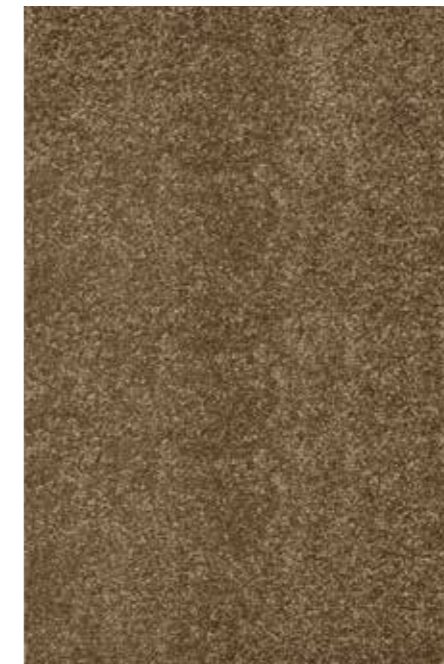

Trendy

Design D.S. Studio

Trendy

Tappeto Trendy Grigio
160 x 230 cm / 200 x 300 cm
Tappeto Trendy Antracite
160 x 230 cm / 200 x 300 cm
Tappeto Trendy Marrone
160 x 230 cm / 200 x 300 cm
Tappeto Trendy Beige
160 x 230 cm / 200 x 300 cm

Collezione di tappeti in tinta unita realizzati in poliestere, facili da pulire e disponibili in quattro differenti tonalità. Si possono richiedere in due misure diverse e sono coordinabili con qualsiasi tipo di arredamento. I colori selezionati ben si sposano con le diverse tonalità dei rivestimenti dei salotti e con le finiture dei complementi.

Collection of solid-colour carpets made of polyester, easy to clean and available in four different shades. They can be requested in two different sizes and can be coordinated with any type of furniture. The selected colours go well with the different shades of the living room coverings and with the finishes of the accessories.

Collection de tapis en polyester de couleur unie, facile à nettoyer et disponible en quatre teintes différentes. Ils peuvent être demandés en deux tailles différentes et peuvent être coordonnés avec tout type de mobilier. Les couleurs choisies se marient bien avec les différentes nuances des revêtements de la salle de séjour et avec les finitions des accessoires.



Rombo PAG. 156



Losanga PAG. 158



Foglia PAG. 160



Fiore PAG. 162



Greca PAG. 164



Natura PAG. 166

Carta da parati



Rombo

Rombo 01 Grigio chiaro
 Rombo 02 Grigio scuro
 Rombo 03 Grigio ruggine

Una carta da parati esclusiva che sovrappone un disegno a rombi ad un fondo délavé. Lo sviluppo dei disegni della carta raffigurati a destra è ottimizzato per una parete da 6 mt di larghezza per 3 mt di altezza. Qui sopra si può capire la grandezza reale del rombo. Facile da abbinare, disponibile in tre diversi colori a seconda dei gusti.

An exclusive wallpaper that superimposes a diamond pattern on a délavé background. The development of the paper patterns shown on the right is optimized for a wall 6 m wide by 3 m high. In the picture above you can see the actual size of the rhombus. Easy to match, available in three different colours according to taste.

Un papier peint exclusif qui superpose un motif de losanges sur un fond délavé. Le développement des modèles de papier présentés à droite est optimisé pour un mur de 6 m de large par 3 m de haut. Sur la photo ci-dessus, vous pouvez voir la taille réelle du losange. Facile à assortir, disponible en trois couleurs différentes.

Rombo

Design D.S. Studio



Rombo 01 - Esempio formato 600 x 300 cm / Size example 600 x 300 cm / Exemple de format 600 x 300 cm

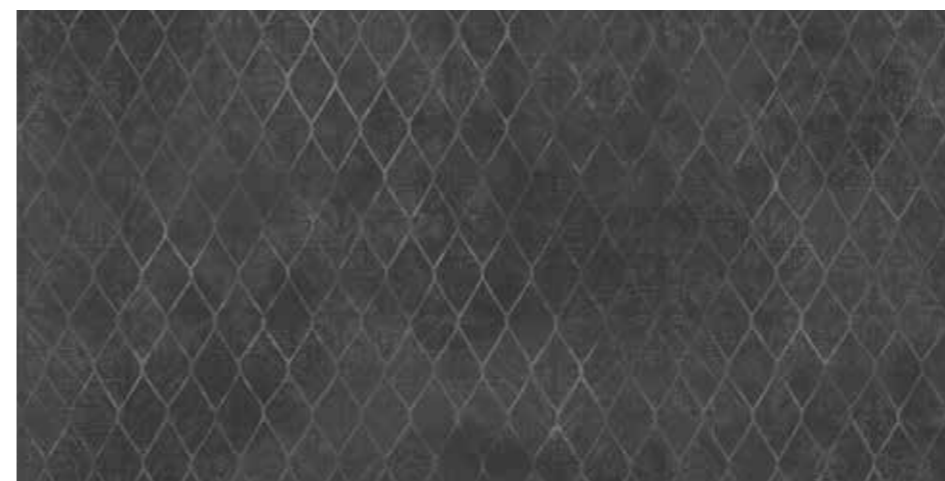

Rombo 02 - Esempio formato 600 x 300 cm / Size example 600 x 300 cm / Exemple de format 600 x 300 cm



Rombo 03 - Esempio formato 600 x 300 cm / Size example 600 x 300 cm / Exemple de format 600 x 300 cm



Losanga

Losanga 01 Carta da zucchero

Losanga 02 Antracite

Losanga 03 Arancio Mattone

L'eleganza del disegno e i tenui colori permettono alla carta da parati Losanga di rendere un ambiente unico ed esclusivo. Lo sviluppo dei disegni della carta raffigurati a destra è ottimizzato per una parete da 6 mt di larghezza per 3 mt di altezza. Qui sopra nella foto ambientata si può capire la grandezza reale del disegno. Facile da abbinare, disponibile in tre diversi colori da scegliere.

The elegance of the pattern and the soft colors allow the Losanga wallpaper to make a unique and exclusive environment. The development of the paper drawings shown on the right is optimized for a 6 m wide by 3 m high wall. Here above in the photo set you can understand the real size of the drawing. Easy to match, available in three different colors to choose at will.

L'élégance du design et les couleurs douces permettent au papier peint Losanga de créer un environnement unique et exclusif. Le développement des dessins sur papier présentés à droite est optimisé pour un mur de 6 m de large par 3 m de hauteur. Ci-dessus, dans la série de photos, vous pouvez comprendre la taille réelle du dessin. Facile à assortir, disponible en trois couleurs différentes à choisir à volonté.



Losanga 01 - Esempio formato 600 x 300 cm / Size example 600 x 300 cm / Exemple de format 600 x 300 cm

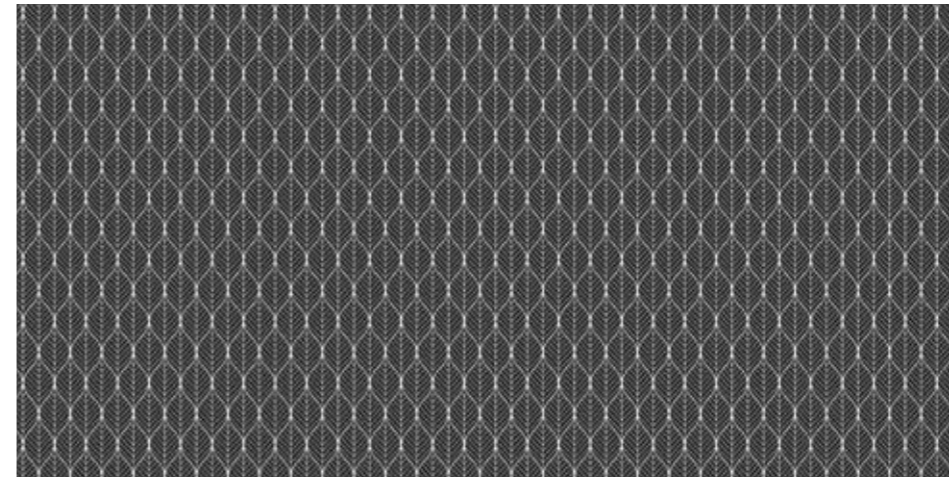

Losanga 02 - Esempio formato 600 x 300 cm / Size example 600 x 300 cm / Exemple de format 600 x 300 cm



Losanga 03 - Esempio formato 600 x 300 cm / Size example 600 x 300 cm / Exemple de format 600 x 300 cm

Losanga
Design D.S. Studio



Foglia

Foglia 01 Ruggine
Foglia 02 Grigio
Foglia 03 Verde

Una fantasia che gioca sui colori e le forme della natura. Lo sviluppo dei disegni della carta raffigurati a destra è ottimizzato per una parete da 6 mt di larghezza per 3 mt di altezza. Qui sopra nella foto ambientata si può capire la grandezza reale del disegno. Questo tipo di disegno crea un giardino davvero unico, disponibile in tre diversi colori da scegliere a piacimento.

A fantasy that plays on the colours and shapes of nature. The development of the paper drawings shown on the right is optimized for a 6 m wide by 3 m high wall. Here above in the photo set you can understand the real size of the drawing. This type of drawing creates a really unique garden, available in three different colors to choose at will.

Une fantaisie qui joue sur les couleurs et les formes de la nature. Le développement des dessins sur papier présentés à droite est optimisé pour un mur de 6 m de large par 3 m de hauteur. Ci-dessus, dans la série de photos, vous pouvez comprendre la taille réelle du dessin. Ce type de dessin crée un jardin vraiment unique, disponible en trois couleurs différentes à choisir.



Foglia 01 - Esempio formato 600 x 300 cm / Size example 600 x 300 cm / Exemple de format 600 x 300 cm



Foglia 02 - - Esempio formato 600 x 300 cm / Size example 600 x 300 cm / Exemple de format 600 x 300 cm



Foglia 03 - Esempio formato 600 x 300 cm / Size example 600 x 300 cm / Exemple de format 600 x 300 cm

Foglia
Design D.S. Studio



Fiore 01 - Esempio formato 600 x 300 cm / Size example 600 x 300 cm / Exemple de format 600 x 300 cm



Fiore 02 - Esempio formato 600 x 300 cm / Size example 600 x 300 cm / Exemple de format 600 x 300 cm

Fiore

Design D.S. Studio

Fiore

Fiore 01 Rosa tortora
Fiore 02 Grigio verde

Una rivisitazione in veste moderna di un disegno tradizionale, proposta in due eleganti tonalità. Lo sviluppo dei disegni della carta è ottimizzato per una parete da 6 mt di larghezza per 3 mt di altezza. Nella foto a fianco si può capire la grandezza reale del disegno. È abbinabile sia con un pavimento di legno che uno in resina. Perfetta sia in un ambiente classico sia in uno più moderno.

A modern reinterpretation of a traditional design, proposed in two elegant shades. The development of the paper drawings is optimized for a 6 m wide by 3 m high wall. In the photo on left page you can understand the real size of the drawing. The "Flower" wallpaper can be combined with both a wooden and a resin floor. Perfect both in a classic and in a more modern environment.

Une réinterprétation moderne d'un design traditionnel, proposé en deux teintes élégantes. Le développement du design est optimisé pour un mur de 6 m de large par 3 m de haut. Dans l'image ci-contre, vous pouvez comprendre la taille réelle du dessin. Il peut être combiné avec un sol en bois et un sol en résine. Parfait dans un contexte classique et moderne.

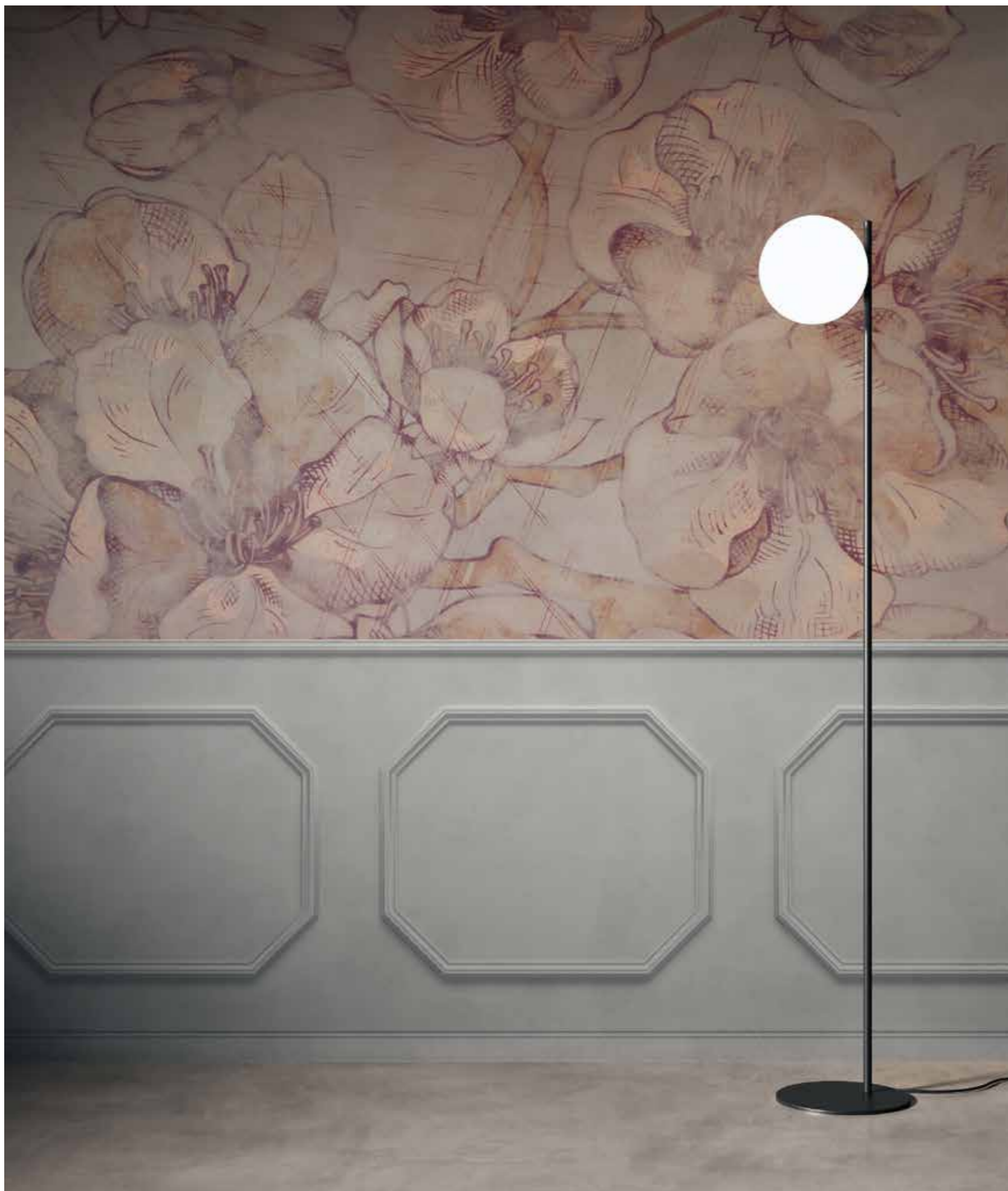

Greca 01 - Esempio formato 600 x 300 cm / Size example 600 x 300 cm / Exemple de format 600 x 300 cm



Greca 02 - Esempio formato 600 x 300 cm / Size example 600 x 300 cm / Exemple de format 600 x 300 cm

Greca

Design D.S. Studio

Greca

Greca 01 Rosa tortora
Greca 02 Grigio verde

Il richiamo alla tradizione e alle boiserie è ottimamente rappresentato nella carta da parati Greca. Lo sviluppo dei disegni della carta è ottimizzato per una parete da 6 mt di larghezza per 3 mt di altezza. Nella foto ambientata si può capire la grandezza reale del disegno. Abbinabile soprattutto in un arredamento classico dove i valori sono fondamentali e dove tutto è perfetto. Disponibile in due tonalità diverse.

The reference to tradition and woodwork is well represented in Greca wallpaper. The development of the paper drawings is optimized for a 6 m wide by 3 m high wall. In the photo set you can understand the real size of the drawing. Can be combined especially in a classic furniture where values are fundamental and where everything is perfect. Available in two different shades.

La référence à la tradition et au travail du bois est bien représentée dans le papier peint Greca. Le développement des dessins est optimisé pour un mur de 6 m de large par 3 m de haut. Sur l'image ci-contre, vous pouvez voir la taille réelle du dessin. Combinable surtout dans un mobilier classique où les valeurs sont fondamentales et où tout est parfait. Disponible en deux teintes différentes.



Natura

Natura 01 Verde smeraldo
 Natura 02 Verde brillante
 Cemento 01 Bianco grigio

Un disegno esclusivo che richiama al green in contrasto con il cemento di base. Nella foto ambientata qui in alto si può comprendere la grandezza reale del disegno. Una decorazione abbinabile in qualsiasi contesto perché unica e meravigliosa. È disponibile in due tonalità di verde. Il disegno con solo il cemento rende comunque particolare e sofisticata la parete grazie alla sua forte personalità.

An exclusive design that recalls the green in contrast with the base cement. In the picture above you can understand the real size of the design. A decoration that can be combined in any context because it is unique and wonderful. It is available in two shades of green. The design with only cement makes the wall particular and sophisticated thanks to its strong personality.

Un design exclusif qui rappelle le vert en contraste avec le ciment de base. Sur l'image ci-dessus, vous pouvez comprendre la taille réelle du dessin. Une décoration qui peut être combinée dans n'importe quel contexte car elle est unique et merveilleuse. Il est disponible en deux teintes de vert. La conception avec seulement du ciment rend le mur particulier et sophistiqué grâce à sa forte personnalité.

Natura

Design D.S. Studio



Natura 01 - Esempio formato 600 x 300 cm / Size example 600 x 300 cm / Exemple de format 600 x 300 cm



Natura 02 - Esempio formato 600 x 300 cm / Size example 600 x 300 cm / Exemple de format 600 x 300 cm



Cemento 01 - Esempio formato 600 x 300 cm / Size example 600 x 300 cm / Exemple de format 600 x 300 cm

Accessori



Lampade PAG. 170



Specchi PAG. 172



Quadri PAG. 174



Cuscini PAG. 176

Lampade

Design W. Kraus



Vita

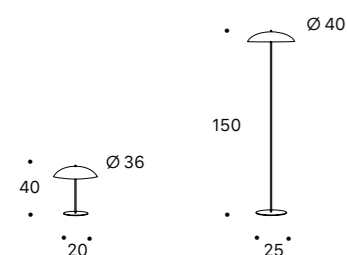

Linee tradizionali per una collezione di lampade esclusive firmate Doimo Salotti che ben si contestualizzano sia in ambienti tradizionali, classici e moderni. La collezione propone la versione piantana da lettura o la lampada da tavolo. Struttura in metallo disponibile in due tonalità di colore: Grigio Antracite goffrato o Avorio Champagne.

Traditional lines for a collection of exclusive lamps signed by Doimo Salotti that are well contextualized both in traditional, classic and modern environments. The collection proposes the free-standing reading version or the table lamp. Metal structure available in two colour shades: Grey Embossed Anthracite or Champagne Ivory.

Des lignes traditionnelles pour une collection de lampes exclusives signées par Doimo Salotti qui sont bien contextualisées dans des environnements traditionnels, classiques et modernes. La collection propose la version de lecture autonome ou la lampe de table. Structure métallique disponible en deux teintes: Gris Anthracite gaufré ou Champagne Ivoire.

Regan

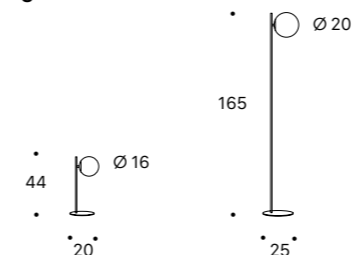

Design e minimalismo per un'esclusiva collezione di lampade firmate Doimo Salotti. La struttura in metallo può essere realizzata con le finiture Grigio Antracite goffrato o Avorio Champagne, la sfera è in vetro satinato. Disponibile nella versione piantana o lampada da tavolo. Funzionalità e design si fondono insieme per un connubio perfetto.

Design and minimalism for an exclusive collection of lamps by Doimo Salotti. The metal structure can be realized with embossed Grey Embossed Anthracite or Champagne Ivory finishes, the sphere is in satin glass. Available in free-standing or table lamp version. Functionality and design come together for a perfect marriage.

Design et minimalisme pour une collection exclusive de lampes de Doimo Salotti. La structure métallique peut être réalisée avec des finitions gaufrées Gris Anthracite gaufré ou Champagne Ivoire, la sphère est en verre satiné. Disponible en version sur pied ou lampe de table. Fonctionnalité et design s'allient pour un mariage parfait.



Specchi

Design W. Kraus



Astra

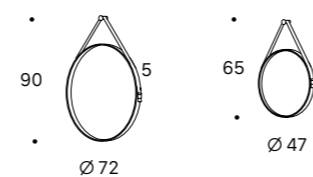

Lo specchio Astra ha la forma perfettamente rotonda e si può richiedere in due diverse misure. Grazie alle sue linee semplici e ben definite, lo specchio sostenuto dalla cinghia in cuoietto si trasforma in un esclusivo oggetto d'arredo posizionabile in qualsiasi parete. La cornice di Astra è realizzabile nei colori laccati a campionario, mentre la cinghia è disponibile nei colori Bianco o Cuoio.

The Astra mirror has a perfectly round shape and can be ordered in two different sizes. Thanks to its simple and well defined lines, the mirror wrapped in a leather frame is transformed into an exclusive furnishing object that can be placed on any wall. The frame of Astra is available in lacquered colours, while the strap is available in leather color-White and Natural.

Le miroir Astra a une forme parfaitement ronde et peut être commandé en deux tailles différentes. Grâce à ses lignes simples et bien définies, le miroir supporté dans un cadre en cuir se transforme en un objet d'ameublement exclusif qui peut être placé sur n'importe quel mur. Le cadre de l'Astra est disponible dans des couleurs laquées, tandis que le bracelet est disponible en cuir Blanc ou Naturel.



01



02



03



04



05



06



07



08



09



10



11



12

Quadri

Design D.S. Studio



Quadri

Misura 42 x 52 cm

Una collezione esclusiva di 12 grafiche confezionate con un'elegante cornice nera e vetro trasparente. Possono essere posizionati a gruppi di due, tre, quattro o multipli a seconda della parete e dell'arredamento. Le immagini originali e rigorosamente in bianco e nero ben si sposano in qualsiasi ambiente della casa, ufficio o sale di attesa. Semplici ed eleganti, originali e raffinati.

An exclusive collection of 12 graphics packaged with an elegant black frame and transparent glass. They can be placed in groups of two, three, four or multiple depending on the wall and furniture. The original and rigorously black and white images blend well in any corner of the house, office or waiting room. Simple and elegant, original and refined.

Une collection exclusive de 12 graphiques montés dans un élégant cadre noir et un verre transparent. Ils peuvent être placés par groupes de deux, trois, quatre ou multiples selon le mur et le mobilier. Les images originales et strictement en noir et blanc s'intègrent bien dans n'importe quel environnement de la maison, du bureau ou de la salle d'attente. Simple et élégant, et original.



Cuscini

Design D.S. Studio



Cuscino multifunzione in poliuretano con piano in legno diam. cm 36



Cuscino multifunzione in poliuretano - L 30 P 58 H 11



Cuscino multifunzione in poliuretano con piano in legno diam. cm 36



Cuscini sfoderabili in piuma e ovatta di varie misure

Cuscini optional

Misure varie - sfoderabili

Various sizes - removable covers

Différentes tailles - couvertures amovibles

La ricca collezione degli esclusivi cuscini di Doimo Salotti è formata da diverse tipologie di materiali, misure e forme, dal più piccolo che misura 36 x 36 cm al più grande da 72 x 72 cm. Si possono avere in ovatta, in misto piuma o completamente in piuma. Ci sono inoltre cuscini multifunzione con piano di appoggio, cuscini portanti poggiatesta e soffici poggiatesta di varie misure, comodi e di grande impatto estetico.

The rich collection of cushions by Doimo Salotti consists of different types of materials, sizes and shapes, from the smallest which measures 36 x 36 cm to the largest which measures 72 x 72 cm. You can have them in wadding, mixed feather or completely feather. There are also multi-functional cushions with support surface, elbow-rest cushions and soft backrests of various sizes, comfortable and of great aesthetic impact.

La riche collection de coussins de Doimo Salotti se compose de différentes tailles et formes, du plus petit qui mesure 36 x 36 cm au plus grand qui mesure 72 x 72 cm. Ils peuvent être en ouate, en plumes mélangées ou en plumes. Il existe des coussins multifonctionnels avec surface d'appui, des accoudoirs rigides et des dossiers souples de différentes tailles, confortables et d'un grand impact esthétique.



Cuscini volanti optional

Cushions optional / Coussins facultatifs

36 x 36 cm - Cuscino con imbottitura in ovatta

Wadding cushion / Coussin avec ouate

40 x 40 cm - Cuscino con imbottitura in ovatta

Wadding cushion / Coussin avec ouate

45 x 45 cm - Cuscino con imbottitura in ovatta

Wadding cushion / Coussin avec ouate

50 x 25 cm - Cuscino con imbottitura in ovatta

Wadding cushion / Coussin avec ouate

60 x 60 cm - Cuscino con imbottitura in ovatta

Wadding cushion / Coussin avec ouate

70 x 40 cm - Cuscino con imbottitura in ovatta

Wadding cushion / Coussin avec ouate

60 x 45 cm - Cuscino in ovatta con rullo Ø 10 cm

Wadding cushion with roller Ø 10 cm / Coussin en ouate avec rouleau Ø 10 cm

80 x 45 cm - Cuscino in ovatta con rullo Ø 10 cm

Wadding cushion with roller Ø 10 cm / Coussin en ouate avec rouleau Ø 10 cm

L 54 Ø 16 cm - Cuscino a rullo con bottoni - imbottitura in poliuretano

*Roller cushion with buttons L 54 Ø 16 cm - polyurethane padding
Coussin à roulettes avec boutons L 54 Ø 16 cm - rembourrage en polyuréthane*

30 x 58 cm - Cuscino multifunzione - imbottitura in poliuretano

*Multifunctional cushion - polyurethane padding
Coussin multifonctionnel - rembourrage en polyuréthane*

Ø 36 Cuscino multifunzione con piano legno - imbottitura in poliuretano

*Multifunctional cushion with wooden top - polyurethane padding
Coussin multifonctionnel avec plateau en bois - rembourrage en polyuréthane*

36 x 36 cm - Cuscino con imbottitura misto piuma

With mixed feather padding / Avec un rembourrage en plumes mélangées

40 x 40 cm - Cuscino con imbottitura misto piuma

With mixed feather padding / Avec un rembourrage en plumes mélangées

45 x 45 cm - Cuscino con imbottitura misto piuma

With mixed feather padding / Avec un rembourrage en plumes mélangées

50 x 25 cm - Cuscino con imbottitura misto piuma

With mixed feather padding / Avec un rembourrage en plumes mélangées

55 x 30 cm - Cuscino morbido con imbottitura misto piuma

With mixed feather padding / Avec un rembourrage en plumes mélangées

60 x 60 cm - Cuscino con imbottitura misto piuma

With mixed feather padding / Avec un rembourrage en plumes mélangées

70 x 40 cm - Cuscino con imbottitura misto piuma

With mixed feather padding / Avec un rembourrage en plumes mélangées

48 x 48 cm - Cuscino morbido con imbottitura in piuma

Soft cushion - feather padding / Coussin souple - rembourrage en plumes

54 x 54 cm - Cuscino con imbottitura in piuma

Feather padding / Rembourrage en plumes

55 x 55 cm - Cuscino a 4 fasce con imbottitura in piuma

4-band feather padding / Rembourrage de plumes à 4 bandes

62 x 62 cm - Cuscino morbido con imbottitura in piuma

Soft cushion - feather padding / Coussin souple - rembourrage en plumes

66 x 66 cm - Cuscino con imbottitura in piuma

Feather padding / Rembourrage en plumes

67 x 67 cm - Cuscino morbido con imbottitura in piuma

Soft cushion - feather padding / Coussin souple - rembourrage en plumes

72 x 72 cm - Cuscino con volant a taglio vivo - imbottitura in piuma

Cushion with raw cut ruffles - feather padding / Coussin à volants coupés bruts - rembourrage en plumes





POLTRONCINE PAG. 184

POUF PAG. 194

TAVOLINI PAG. 202

MADIE PAG. 210

LIBRERIE PAG. 215

MATERIALI E FINITURE PAG. 218

Note tecniche

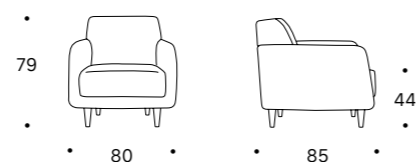

L totale cm 80 P totale cm 85 H totale cm 79
 P seduta cm 55 H seduta cm 44
 H bracciolo cm 61 L bracciolo cm 12

Piede di serie: piede in legno H 14 cm in finitura Rovere Cenere, disponibile nelle finiture Canaletto o Noce Naturale.
Piede optional: piede in Alluminio Opaco H 14 cm.

La struttura è realizzata in legno, l'imbottitura in poliuretano espanso. Il cuscino di seduta è realizzato in poliuretano espanso densità 35 kg/mc. Lo schienale è realizzato in poliuretano espanso a doppia densità 25/35 kg/mc. Adele è rivestibile in tessuto, microfibra, ecopelle e pelle ed è completamente sfoderabile tranne che nella versione in pelle.

L total cm 80 D total cm 85 H total cm 79
 D seat cm 55 H seat cm 44
 H armrest cm 61 L armrest cm 12

Standard feet: wooden feet H 14 cm Rovere Cenere finish, available in Canaletto or Noce Naturale finishes.
Optional feet: Matt Aluminium feet H 14 cm.

The structure is made of wood, the padding of polyurethane foam. The seat cushion is made of polyurethane foam density 35 kg/mc. The backrest is made of polyurethane foam with double density 25/35 kg/mc. Adele can be upholstered in fabric, microfibre, leatherette and leather and has completely removable covers except for the leather version.

L total cm 80 P total cm 85 H total cm 79
 P siège cm 55 H siège cm 44
 H accudoir cm 61 L accudoir cm 12

Pied standard: pied en bois H 14 cm finition Rovere Cenere, disponible en finition Canaletto ou Noce Naturale.
Pied optionnel: pied en Aluminium Mat H 14 cm.

La structure est en bois, le rembourrage en mousse de polyuréthane. Le coussin de siège est en mousse de polyuréthane de densité 35 kg/mc. Le dossier est en mousse de polyuréthane à double densité 25/35 kg/mc. Adele peut être revêtue de tissu, de microfibres, de simili-cuir et de cuir et possède des housses entièrement amovibles, sauf pour la version en cuir.

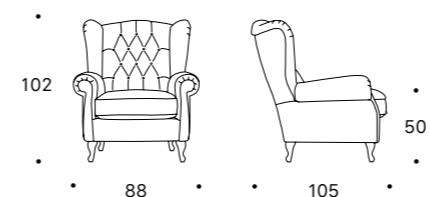

L totale cm 88 P totale cm 105 H totale cm 102
 P seduta cm 59 H seduta cm 50
 H bracciolo cm 62 L bracciolo cm 20

Piede di serie: piede in legno H 15 cm in finitura Rovere Cenere, disponibile nelle finiture Canaletto o Noce Naturale.

La struttura è realizzata in legno, l'imbottitura in poliuretano espanso. Il cuscino di seduta è realizzato in poliuretano espanso densità 30 kg/mc e cuffia in piuma d'oca. Lo schienale è realizzato in poliuretano espanso densità 30 kg/mc. Bergere è rivestibile in tessuto, microfibra, ecopelle e pelle, **non sfoderabile**.

L total cm 88 D total cm 105 H total cm 102
 D seat cm 59 H seat cm 50
 H armrest cm 62 L armrest cm 20

Standard feet: wooden feet H 15 cm Rovere Cenere finish, available in Canaletto or Noce Naturale finishes.

The structure is made of wood, the padding of polyurethane foam. The seat cushion is made of polyurethane foam density 30 kg/mc and goose down cap. The backrest is made of polyurethane foam density 30 kg/mc. Bergere is covered in fabric, microfibre, leatherette and leather, **not removable**.

L total cm 88 P total cm 105 H total cm 102
 P siège cm 59 H siège cm 50
 H accudoir cm 62 L accudoir cm 20

Pied standard: pied en bois H 15 cm finition Rovere Cenere, disponible en finition Canaletto ou Noce Naturale.

La structure est en bois, le rembourrage en mousse de polyuréthane. Le coussin de siège sont en mousse de polyuréthane de densité 30 kg/mc et en duvet d'oie. Le dossier est en mousse de polyuréthane de densité 30 kg/mc. Le Bergere peut être revêtue de tissu, de microfibres, de simili-cuir et cuir **toujours pas déshoussable**.

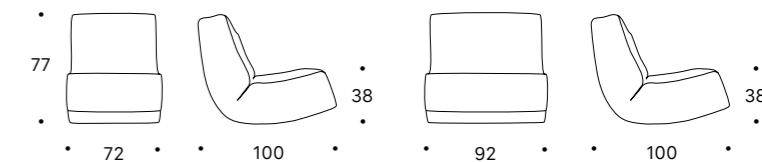

L totale cm 72 / 92 P totale cm 100 H totale cm 77
 P seduta cm 61 H seduta cm 38
 H bracciolo -- L bracciolo --

La struttura è realizzata in legno. La seduta è realizzata in poliuretano espanso densità 30 kg/mc. Lo schienale è realizzato in poliuretano espanso densità 18 kg/mc. Dondolami è rivestibile in tessuto, microfibra, ecopelle e pelle ed è sempre completamente sfoderabile. Comodissima per chi ama dondolarsi e rilassarsi ascoltando della buona musica ad occhi chiusi. Dondolami ha una seduta molto comoda, in coppia o in trio formano un divanetto a sedute indipendenti. Disponibile in due diverse misure a seconda dello spazio disponibile.

L total cm 72 / 92 D total cm 100 H total cm 77
 D seat cm 61 H seat cm 38
 H armrest -- L armrest --

The structure is made of wood. The seat is made of polyurethane foam density 30 kg/mc. The backrest is made of polyurethane foam density 18 kg/mc. Dondolami can be upholstered in fabric, microfibre, leatherette and leather and is always completely removable. Very comfortable for those who love to swing and relax listening to good music with their eyes closed. Dondolami has a very comfortable seat, in pairs or in trio form a sofa with independent seats. Available in two different sizes depending on the space available.

L total cm 72 / 92 P total cm 100 H total cm 77
 P siège cm 61 H siège cm 38
 H accudoir -- L accudoir --

La structure est en bois. Le siège est fait de mousse de polyuréthane de densité 30 kg/mc. Le dossier est en mousse de polyuréthane de densité 18 kg/mc. Le Dondolami peut être revêtu de tissu, de microfibres, de simili-cuir et de cuir et est toujours entièrement déhoussable. Très confortable pour ceux qui aiment se balancer et se détendre en écoutant de la bonne musique les yeux fermés. Dondolami dispose d'un siège très confortable, en paire ou en trio forment un canapé avec des sièges indépendants. Disponible en deux tailles différentes en fonction de l'espace disponible.

Isabel - PAG. 28

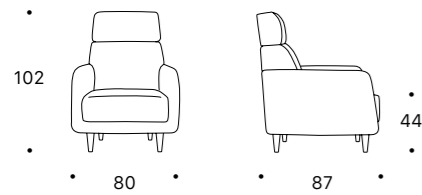

L totale cm 80 P totale cm 87 H totale cm 102
 P seduta cm 55 H seduta cm 44
 H bracciolo cm 61 L bracciolo cm 12

Piede di serie: piede in legno H 14 cm in finitura Rovere Cenere, disponibile nelle finiture Canaletto o Noce Naturale.
Piede optional: piede in Alluminio Opaco H 14 cm.

La struttura è realizzata in legno, l'imbottitura in poliuretano espanso. Il cuscino di seduta è realizzato in poliuretano espanso densità 35 kg/mc. Lo schienale è realizzato in poliuretano espanso a doppia densità 16/25/35 kg/mc. Isabel è rivestibile in tessuto, microfibra, ecopelle e pelle ed è completamente sfoderabile tranne che nella versione in pelle.

L total cm 80 D total cm 87 H total cm 102
 D seat cm 55 H seat cm 44
 H armrest cm 61 L armrest cm 12

Standard feet: wooden feet H 14 cm Rovere Cenere finish, available in Canaletto or Noce Naturale finishes.
Optional feet: Matt Aluminium feet H 14 cm.

The structure is made of wood, the padding of polyurethane foam. The seat cushion is made of polyurethane foam density 35 kg/mc. The backrest is made of triple density polyurethane foam 16/25/35 kg/mc. Isabel can be upholstered in fabric, microfibre, leatherette and leather and has completely removable covers except for the leather version.

L total cm 80 P total cm 87 H total cm 102
 P siège cm 55 H siège cm 44
 H accudoir cm 61 L accudoir cm 12

Pied standard: pied en bois H 14 cm finition Rovere Cenere, disponible en finition Canaletto ou Noce Naturale.
Pied optionnel: pied en Aluminium Mat H 14 cm.

La structure est en bois, le rembourrage en mousse de polyuréthane. Les coussin de siège est en mousse de polyuréthane de densité 35 kg/mc. Le dossier est en mousse de polyuréthane triple densité 16/25/35 kg/mc. Isabel peut être revêtue de tissu, de microfibres, de simili-cuir et de cuir et possède des housses entièrement amovibles, sauf pour la version en cuir.

Jessica - PAG. 40

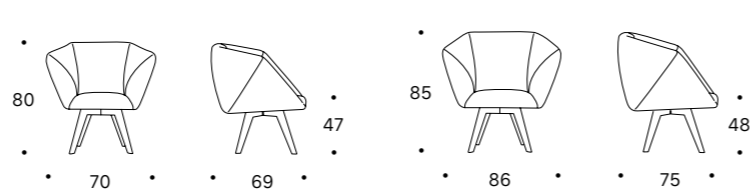

Poltroncina L cm 70 Poltroncina L cm 86
 P totale cm 69 H totale cm 80 P totale cm 75 H totale cm 85
 P seduta cm 52 H seduta cm 47 P seduta cm 58 H seduta cm 48
 H bracciolo -- L bracciolo cm 12 H bracciolo -- L bracciolo cm 12

Piede di serie: piede in legno H 38 cm in finitura Rovere Cenere, disponibile nelle finiture Canaletto o Noce Naturale.

La struttura è realizzata multistrato. La seduta è realizzata in poliuretano espanso densità 40 kg/mc. Lo schienale è realizzato in poliuretano espanso doppia densità 18/30 kg/mc, per la poltroncina da 70, mentre è in tripla densità 18/30/35 kg/mc per la misura da 86. Jessica è rivestibile in tessuto, microfibra, ecopelle e pelle, **sempre non sfoderabile**.

Small chair L cm 70 Small chair L cm 86
 D total cm 69 H totale cm 80 D total cm 75 H total cm 85
 D seat cm 52 H seat cm 47 D seat cm 58 H seat cm 48
 H armrest -- L armrest cm 12 H armrest -- L armrest cm 12

Standard feet: wooden feet H 14 cm Rovere Cenere finish, available in Canaletto or Noce Naturale finishes.

The structure is made of plywood. The seat is made of polyurethane foam density 40 kg/mc. The backrest is made of double density polyurethane foam 18/30 kg/mc for the 70 cm version, while it is in triple density 18/30/35 kg/mc for the 86 cm version. Jessica can be upholstered in fabric, microfibre, leatherette and leather that **cannot be removed**.

Fauteuil de 70 cm Fauteuil de 86 cm
 P total cm 69 H total cm 80 P total cm 75 H total cm 85
 P siège cm 52 H siège cm 47 P siège cm 58 H siège cm 48
 H accudoir -- L accudoir cm 12 H accudoir -- L accudoir cm 12

Pied standard: pied en bois H 14 cm finition Rovere Cenere, disponible en finition Canaletto ou Noce Naturale.

La structure est constituée de plusieurs couches. Le siège est fait de mousse de polyuréthane de densité 40 kg/mc. Le dossier est en mousse de polyuréthane double densité 18/30 kg/mc, pour la chaise 70, alors qu'il est en triple densité 18/30/35 kg/mc pour la taille 86. Jessica peut être revêtue de tissu, de microfibres, de simili-cuir et de cuir **non déhoussable**.

Karin - PAG. 24

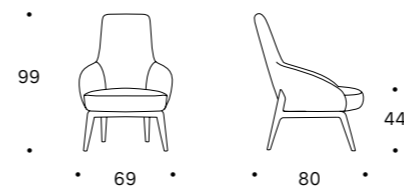

L totale cm 69 P totale cm 80 H totale cm 99
 P seduta cm 57 H seduta cm 44
 H bracciolo cm 55 L bracciolo --

Piede di serie: piede in legno H 29 cm in finitura Rovere Cenere, disponibile nelle finiture Canaletto o Noce Naturale.

La struttura è realizzata in legno. La seduta è realizzata in poliuretano espanso densità 40 kg/mc. Lo schienale è realizzato in poliuretano espanso a doppia densità 30/35 kg/mc. Grazie al suo schienale alto, Karin rimane una poltroncina molto comoda dalle misure contenute. Karin è rivestibile in tessuto, microfibra, ecopelle e pelle, **sempre non sfoderabile**.

L total cm 69 D total cm 80 H total cm 99
 D seat cm 57 H seat cm 44
 H armrest cm 55 L armrest --

Standard feet: wooden feet H 14 cm Rovere Cenere finish, available in Canaletto or Noce Naturale finishes.

The structure is made of wood. The seat is made of polyurethane foam density 40 kg/mc. The backrest is made of double density polyurethane foam 30/35 kg/mc. Thanks to its high backrest, Karin remains a very comfortable small armchair. Karin can be upholstered in fabric, microfibre, leatherette and leather that **cannot be removed**.

L total cm 69 P total cm 80 H total cm 99
 P siège cm 57 H siège cm 44
 H accudoir cm 55 L accudoir --

Pied standard: pied en bois H 14 cm finition Rovere Cenere, disponible en finition Canaletto ou Noce Naturale.

La structure est en bois. Le siège est fait de mousse de polyuréthane de densité 40 kg/mc. Le dossier est en mousse de polyuréthane de double densité 30/35 kg/mc. Grâce à son haut dossier, Karin reste un petit fauteuil très confortable. Karin peut être revêtue de tissu, de microfibres, de simili-cuir et de cuir **non déhoussable**.

Kelly - PAG. 16

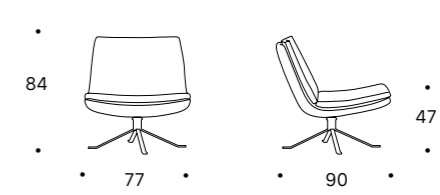

L totale cm 77 P totale cm 90 H totale cm 84
 P seduta cm 56 H seduta cm 47
 H bracciolo -- L bracciolo --

Piede di serie: struttura in metallo H 24 cm in finitura Bronzo Vintage, disponibile anche nel colore 013 Grigio Piombo.

La struttura è realizzata in multistrato rivestito da vellutino accoppiato. Il cuscino di seduta è realizzato in poliuretano espanso densità 35 kg/mc. Lo schienale è realizzato in poliuretano espanso a doppia densità 18/35 kg/mc. Kelly è rivestibile in tessuto, microfibra, ecopelle e pelle ed è completamente sfoderabile tranne che nella versione in pelle.

L total cm 77 D total cm 90 H total cm 84
 D seat cm 56 H seat cm 47
 H armrest -- L armrest --

Standard feet: metal support H 24 cm in Bronzo Vintage finish, also available in Grigio Piombo 013.

The structure is made of plywood covered with resin-coupled velvet. The seat cushion is made of polyurethane foam density 35 kg/mc. The backrest is made of polyurethane foam with double density 18/35 kg/mc. Kelly can be upholstered in fabric, microfibre, leatherette and leather and has completely removable covers except for the leather version.

L total cm 77 P total cm 90 H total cm 84
 P siège cm 56 H siège cm 47
 H accudoir -- L accudoir --

Pied standard: support métallique H 24 cm finition Bronzo Vintage, également disponible en Grigio Piombo 013.

La structure est en bois recouvert de velours synthétique. Le coussin du siège est en mousse de polyuréthane d'une densité de 35 kg/mc. Le dossier est en mousse de polyuréthane de double densité 18/35 kg/mc. Kelly peut être revêtue de tissu, de microfibres, de simili-cuir et de cuir et possède des housses entièrement amovibles, sauf pour la version en cuir.

Lounge - PAG. 8

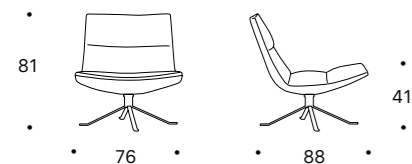

L totale cm 76 P totale cm 88 H totale cm 81
 P seduta cm 57 H seduta cm 41
 H bracciolo -- L bracciolo --

Piede di serie: struttura in metallo H 24 cm in finitura Bronzo Vintage, disponibile anche nel colore 013 Grigio Piombo.

La struttura è realizzata in multistrato rivestito da vellutino accoppiato. La seduta e lo schienale sono realizzati in misto piuma e chips di lattice. Lounge è rivestibile in tessuto, microfibra, ecopelle e pelle, **non sfoderabile**. Il piede di Longe è un basamento girevole a 4 razze in metallo disponibile in due finiture a scelta. Trova il suo posto utile e ideale sia nel classico salotto domestico ma anche negli uffici, sale riunioni o nelle hall degli alberghi.

L total cm 76 D total cm 88 H total cm 81
 D seat cm 57 H seat cm 41
 H armrest -- L armrest --

Standard feet: metal support H 24 cm in Bronzo Vintage finish, also available in Grigio Piombo 013.

The structure is made of plywood covered with resin-coupled velvet. The seat and backrest are made of mixed feather and latex chips. Lounge can be upholstered in fabric, microfibre, leatherette and leather that **cannot be removed**. Lounge's foot is a 4-spoke metal swivel base available in a choice of two finishes. It finds its useful and ideal place both in the classic domestic living room but also in offices, meeting rooms or hotel lobbies.

L total cm 76 P total cm 88 H total cm 81
 P siège cm 57 H siège cm 41
 H accudoir -- L accudoir --

Pied standard: support métallique H 24 cm finition Bronzo Vintage, également disponible en Grigio Piombo 013.

La structure est en bois recouvert de velours synthétique. Le siège et le dossier sont faits de plumes mélangées et chips en latex. Lounge peut être revêtue de tissu, de microfibres, de simili-cuir et de cuir **non déhoussable**. Le pied de Lounge est une base métallique pivotante à 4 branches, disponible en deux finitions. Il trouve sa place utile et idéale à la fois dans le salon domestique classique mais aussi dans les bureaux, les salles de réunion ou les halls d'hôtel.

Luna - PAG. 12

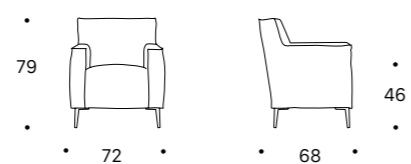

L totale cm 72 P totale cm 68 H totale cm 79
 P seduta cm 47 H seduta cm 46
 H bracciolo cm 60 L bracciolo cm 14

Piede di serie: piede in metallo H 15 cm in finitura Bronzo Vintage, disponibile anche nella finitura Alluminio Opaco.

La struttura è in legno, l'imbottitura in poliuretano espanso e misto piuma. La seduta è realizzata in poliuretano espanso densità 40 kg/mc ricoperto con trapuntino in misto piuma. Lo schienale è realizzato in poliuretano espanso densità 30 kg/mc ricoperto con trapuntino in misto piuma, più fibra di poliestere e chips di lattice. Luna è rivestibile in tessuto, microfibra, ecopelle e pelle ed è completamente sfoderabile tranne che nella versione in pelle.

L total cm 72 D total cm 68 H total cm 79
 D seat cm 47 H seat cm 46
 H armrest cm 60 L armrest cm 14

Standard feet: metal feet H 15 cm with Bronzo Vintage finish, also available in Matt Aluminium finish.

The structure is made of wood, the padding is in polyurethane foam and mixed feather. The seat is made of polyurethane foam density 40 kg/mc covered with mixed feather quilt. The backrest is made of polyurethane foam density 30 kg/mc covered with mixed feather quilt plus polyester fiber and latex chips. Luna can be upholstered in fabric, microfibre, leatherette and leather and has completely removable covers except for the leather version.

L total cm 72 P total cm 68 H total cm 79
 P siège cm 47 H siège cm 46
 H accudoir cm 60 L accudoir cm 14

Pied standard: pied en métal H 15 cm avec finition Bronzo Vintage, également disponible en finition Aluminium Mat.

La structure est en bois, le rembourrage est en mousse de polyuréthane et en plumes mixtes. Le siège est fait de mousse de polyuréthane de densité 40 kg/mc recouverte d'une couette en plumes mixtes. Le dossier est en mousse de polyuréthane de 30 kg/mc de densité, recouvert d'une couette en plumes mixtes, plus de fibres de polyester et de chips de latex. Luna peut être revêtue de tissu, de microfibres, de simili-cuir et de cuir et possède des housses entièrement amovibles, sauf pour la version en cuir.

Miranda - PAG. 32

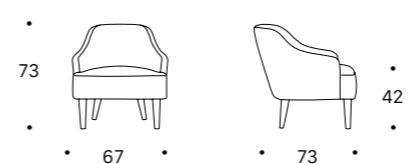

L totale cm 67 P totale cm 73 H totale cm 73
 P seduta cm 57 H seduta cm 42
 H bracciolo cm 55 L bracciolo cm 7

Piede di serie: piede in legno H 22 cm in finitura Rovere Cenere, disponibile nelle finiture Canaletto o Noce Naturale.

La struttura è realizzata multistrato. La seduta è realizzata in poliuretano espanso a doppia densità 40/45 kg/mc. Lo schienale è realizzato in poliuretano espanso a doppia densità 30/40 kg/mc. Miranda è rivestibile in tessuto, microfibra, ecopelle e pelle, **non sfoderabile**.

L total cm 67 D total cm 73 H total cm 73
 D seat cm 57 H seat cm 42
 H armrest cm 55 L armrest cm 7

Standard feet: wooden feet H 22 cm Rovere Cenere finish, available in Canaletto or Noce Naturale finishes.

The structure is made of plywood. The seat is made of double density polyurethane foam 40/45 kg/mc. The backrest is made of double density polyurethane foam 30/40 kg/mc. Miranda can be upholstered in fabric, microfibre, leatherette and leather that **cannot be removed**.

L total cm 67 P total cm 73 H total cm 73
 P siège cm 57 H siège cm 42
 H accudoir cm 55 L accudoir cm 7

Pied standard: pied en bois H 22 cm finition Rovere Cenere, disponible en finition Canaletto ou Noce Naturale.

La structure est constituée de plusieurs couches. Le siège est fait de mousse de polyuréthane double densité 40/45 kg/mc. Le dossier est en mousse de polyuréthane double densité 30/40 kg/mc. Miranda peut être revêtue de tissu, de microfibres, de simili-cuir et de cuir **non déhoussable**.

Moon - PAG. 10

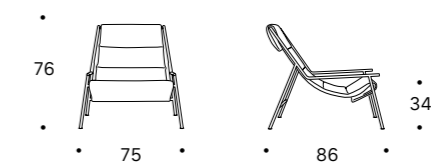

L totale cm 75 P totale cm 86 H totale cm 76
 P seduta cm 50 H seduta cm 34
 H bracciolo cm 40 L bracciolo cm 2

Piede di serie: struttura in metallo in finitura Bronzo Vintage, disponibile anche nel colore 013 Grigio Piombo.

La struttura è realizzata in tubolare metallico verniciato color Bronzo Vintage. Il supporto della seduta è realizzato con un'anima in cuoio. La seduta e lo schienale sono realizzati in poliuretano espanso densità 65 kg/mc. Moon è rivestibile esclusivamente in pelle sempre **non sfoderabile**.

L total cm 75 D total cm 86 H total cm 76
 D seat cm 50 H seat cm 34
 H armrest cm 40 L armrest cm 2

Standard feet: metal frame with Bronzo Vintage finish, also available in 013 Grigio Piombo.

The structure is made of tubular metal painted in Bronzo Vintage color. The seat support is made with a leather core. The seat and backrest are made of polyurethane foam density 65 kg/mc. Moon can be upholstered exclusively in leather, always with **non-removable** covers.

L total cm 75 P total cm 86 H total cm 76
 P siège cm 50 H siège cm 34
 H accudoir cm 40 L accudoir cm 2

Pied standard: cadre métallique avec finition Bronzo Vintage, également disponible en Grigio Piombo 013.

La structure est faite de métal tubulaire peint en couleur Bronzo Vintage. Le support du siège est fait d'un noyau de cuir. L'assise et le dossier sont en mousse de polyuréthane d'une densité de 65 kg/mc. Moon peut être recouvert exclusivement de cuir, toujours avec des housses **non amovibles**.

Nora - PAG. 38

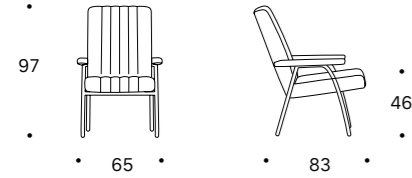

L totale cm 65 P totale cm 83 H totale cm 97
P seduta cm 51 H seduta cm 46
H bracciolo cm 58 L bracciolo cm 8

Piede di serie: telaio in metallo in finitura Bronzo Vintage, disponibile anche nel colore 013 Grigio Piombo.

La struttura è realizzata in legno e multistrato. La seduta è realizzata in poliuretano espanso a doppia densità 40/40 morbido kg/mc. Lo schienale è realizzato in poliuretano espanso densità 40 kg/mc. Nora è rivestibile in tessuto, microfibra, ecopelle e pelle ed è completamente sfoderabile tranne che nella versione in pelle.

L total cm 65 D total cm 83 H total cm 97
D seat cm 51 H seat cm 46
H armrest cm 58 L armrest cm 8

Standard feet: metal frame with Bronzo Vintage finish, also available in 013 Grigio Piombo.

The frame is made of wood and plywood. The seat is made of polyurethane foam with double density 40/40 soft kg/mc. The backrest is made of polyurethane foam density 40 kg/mc. Nora can also be upholstered in fabric, microfibre, leatherette and leather and has completely removable covers except for the leather version.

L total cm 65 P total cm 83 H total cm 97
P siège cm 51 H siège cm 46
H accudoir cm 58 L accudoir cm 8

Pied standard: cadre métallique avec finition Bronzo Vintage, également disponible en Grigio Piombo 013.

Le cadre est fait de bois et de contreplaqué. Le siège est en mousse de polyuréthane à double densité 40/40 soft kg/mc. Le dossier est en mousse de polyuréthane de densité 40 kg/mc. Nora peut être revêtue de tissu, de microfibres, de similicuir et de cuir et est entièrement amovible, sauf pour la version en cuir.

Roberta - PAG. 30

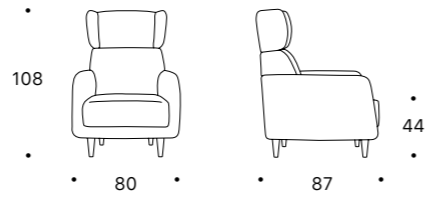

L totale cm 80 P totale cm 87 H totale cm 108
P seduta cm 55 H seduta cm 44
H bracciolo cm 61 L bracciolo cm 12

Piede di serie: piede in legno H 14 cm in finitura Rovere Cenere, disponibile nelle finiture Canaletto o Noce Naturale.
Piede optional: piede in Alluminio Opaco H 14 cm.

La struttura è realizzata in legno, l'imbottitura in poliuretano espanso. Il cuscino di seduta è realizzato in poliuretano espanso densità 35 kg/mc. Lo schienale è realizzato in poliuretano espanso a doppia densità 16/25/35 kg/mc. Isabel è rivestibile in tessuto, microfibra, ecopelle e pelle ed è completamente sfoderabile tranne che nella versione in pelle.

L total cm 80 D total cm 87 H total cm 108
D seat cm 55 H seat cm 44
H armrest cm 61 L armrest cm 12

Standard feet: wooden feet H 14 cm Rovere Cenere finish, available in Canaletto or Noce Naturale finishes.
Optional feet: Matt Aluminium feet H 14 cm.

The structure is made of wood, the padding of polyurethane foam. The seat cushion is made of polyurethane foam density 35 kg/mc. The backrest is made of triple density polyurethane foam 16/25/35 kg/mc. Isabel can be upholstered in fabric, microfibre, leatherette and leather and has completely removable covers except for the leather version.

L total cm 80 P total cm 87 H total cm 108
P siège cm 55 H siège cm 44
H accudoir cm 61 L accudoir cm 12

Pied standard: pied en bois H 14 cm finition Rovere Cenere, disponible en finition Canaletto ou Noce Naturale.
Pied optionnel: pied en Aluminium Mat H 14 cm.

La structure est en bois, le rembourrage en mousse de polyuréthane. Les coussin de siège est en mousse de polyuréthane de densité 35 kg/mc. Le dossier est en mousse de polyuréthane triple densité 16/25/35 kg/mc. Isabel peut être revêtue de tissu, de microfibres, de simili-cuir et de cuir et possède des housses entièrement amovibles, sauf pour la version en cuir.

Sara - PAG. 34

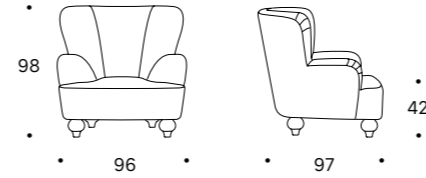

L totale cm 96 P totale cm 97 H totale cm 98
P seduta cm 59 H seduta cm 42
H bracciolo cm 62 L bracciolo --

Piede di serie: piede in legno H 14 cm in finitura Rovere Cenere, disponibile nelle finiture Canaletto o Noce Naturale.

La struttura è in legno e multistrato, l'imbottitura in poliuretano espanso. La seduta è in poliuretano espanso a doppia densità 40/40 morbido kg/mc. Lo schienale è realizzato in poliuretano espanso a doppia densità 35/35 morbido kg/mc. Sara è rivestibile in tessuto, microfibra, ecopelle e pelle ed è completamente sfoderabile tranne che nella versione in pelle.

L total cm 96 D total cm 97 H total cm 98
D seat cm 59 H seat cm 42
H armrest cm 62 L armrest --

Standard feet: wooden feet H 14 cm Rovere Cenere finish, available in Canaletto or Noce Naturale finishes.

The structure is made of wood and plywood, the padding of polyurethane foam. The seat is made of double density soft polyurethane foam 40/40 kg/mc. The backrest is made of double density soft polyurethane foam 35/35 kg/mc. Sara can be upholstered in fabric, microfibre, leatherette and leather and has completely removable covers except for the leather version.

L total cm 96 P total cm 97 H total cm 98
P siège cm 59 H siège cm 42
H accudoir cm 62 L accudoir --

Pied standard: pied en bois H 14 cm finition Rovere Cenere, disponible en finition Canaletto ou Noce Naturale.

La structure est en bois, le rembourrage en mousse de polyuréthane. Les coussin de siège est en mousse de polyuréthane double densité 40/40 souple kg/mc. Le dossier est en mousse de polyuréthane double densité 35/35 souple kg/mc. Sara peut être revêtue de tissu, de microfibres, de simili-cuir et de cuir et possède des housses entièrement amovibles, sauf pour la version en cuir.

Tania - PAG. 36

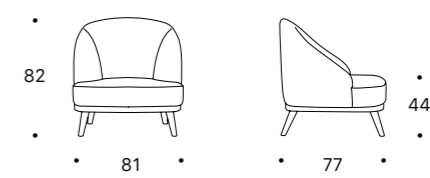

L totale cm 81 P totale cm 77 H totale cm 82
P seduta cm 56 H seduta cm 44
H bracciolo -- L bracciolo cm 12

Piede di serie: basamento in legno H 25 cm in finitura Rovere Cenere, disponibile nelle finiture Canaletto o Noce Naturale.

La struttura è realizzata in legno, l'imbottitura in poliuretano espanso. La seduta è realizzata in poliuretano espanso a doppia densità 25/30 kg/mc. Lo schienale è realizzato in poliuretano espanso a doppia densità 21/25 kg/mc. Tania è rivestibile in tessuto, microfibra, ecopelle e pelle ed è completamente sfoderabile tranne che nella versione in pelle.

L total cm 81 D total cm 77 H total cm 82
D seat cm 56 H seat cm 44
H armrest -- L armrest cm 12

Standard feet: wooden base H 25 cm Rovere Cenere finish, available in Canaletto or Noce Naturale finishes.

The structure is made of wood, the padding of polyurethane foam. The seat is made of polyurethane foam with double density 25/30 kg/mc. The backrest is made of polyurethane foam with double density 21/25 kg/mc. Tania can be upholstered in fabric, microfibre, leatherette and leather and has completely removable covers except for the leather version.

L total cm 81 P total cm 77 H total cm 82
P siège cm 56 H siège cm 44
H accudoir -- L accudoir cm 12

Pied standard: socle en bois H 25 cm finition Rovere Cenere, disponible en finition Canaletto ou Noce Naturale.

La structure est en bois, le rembourrage en mousse de polyuréthane. Le siège est en mousse de polyuréthane à double densité 25/30 kg/mc. Le dossier est en mousse de polyuréthane à double densité 21/25 kg/mc. Tania peut être revêtue de tissu, de microfibres, de simili-cuir et de cuir et possède des housses entièrement amovibles, sauf pour la version en cuir.

Thelma - PAG. 22

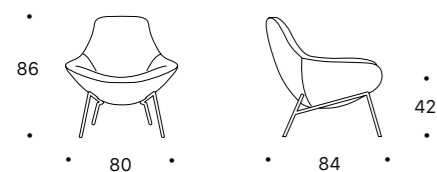

L totale cm 80 P totale cm 84 H totale cm 86
P seduta cm 54 H seduta cm 42
H bracciolo cm 57 L bracciolo --

Piede di serie: struttura tubolare in metallo finitura Bronzo Vintage, disponibile anche nel colore 013 Grigio Piombo.

La struttura è realizzata in metallo.
La seduta è realizzata in schiumato a freddo doppia densità 60/70 kg/mc.
Lo schienale è realizzato in schiumato a freddo doppia densità 60/70 kg/mc.
Thelma è rivestibile in tessuto, microfibra, ecopelle e pelle ed è completamente sfoderabile.

L total cm 80 D total cm 84 H total cm 86
D seat cm 54 H seat cm 42
H armrest cm 57 L armrest --

Standard feet: metal frame with Bronzo Vintage finish, also available in 013 Grigio Piombo.

The structure is made of metal.
The seat is made of cold foamed polyurethane double density 60/70 kg/mc.
The backrest is made of cold foamed polyurethane double density foam 60/70 kg/mc.
Thelma can be upholstered in fabric, microfibres, leatherette and leather and is completely removable.

L total cm 80 P total cm 84 H total cm 86
P siège cm 54 H siège cm 42
H accudoir cm 57 L accudoir --

Pied standard: cadre métallique avec finition Bronzo Vintage, également disponible en Grigio Piombo 013.

La structure est en bois, le rembourrage en mousse de polyuréthane.
Le siège est en mousse froide double densité 60/70 kg/mc.
Le dossier est en mousse froide de double densité 60/70 kg/mc.
Thelma peut être revêtue de tissu, de microfibres, de simili-cuir et de cuir et possède des housses entièrement amovibles.

Zoe - PAG. 14

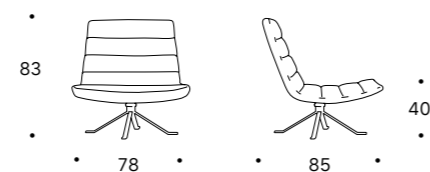

L totale cm 78 P totale cm 85 H totale cm 83
P seduta cm 57 H seduta cm 40
H bracciolo -- L bracciolo --

Piede di serie: struttura in metallo H 24 cm in finitura Bronzo Vintage, disponibile anche nel colore 013 Grigio Piombo.

La struttura è realizzata in multistrato rivestito da vellutino accoppiato.
La seduta e lo schienale sono realizzati in misto piuma e chips di lattice.
Zoe è rivestibile in tessuto, microfibra, ecopelle e pelle ed è completamente sfoderabile tranne che nella versione in pelle.
Il piede di Zoe è un basamento girevole a 4 razze in metallo disponibile in due finiture a scelta. Trova il suo posto utile e ideale sia nel classico salotto domestico ma anche negli uffici, sale riunioni, o nelle hall degli alberghi.

L total cm 78 D total cm 85 H total cm 83
D seat cm 57 H seat cm 40
H armrest -- L armrest --

Standard feet: metal support H 24 cm in Bronzo Vintage finish, also available in Grigio Piombo 013.

The structure is made of plywood covered with resin-coupled velvet.
The seat and backrest are made of mixed feather and latex chips.
Zoe can be upholstered in fabric, microfibres, leatherette and leather and has completely removable covers except for the leather version.
Zoe's feet is a 4-spoke metal swivel base available in a choice of two finishes. It finds its useful and ideal place both in the classic domestic living room but also in offices, meeting rooms, or hotel lobbies.

L total cm 78 P total cm 85 H total cm 83
P siège cm 57 H siège cm 40
H accudoir -- L accudoir --

Pied standard: support métallique H 24 cm finition Bronzo Vintage, également disponible en Grigio Piombo 013.

La structure est en bois recouvert de velours synthétique.
Le siège et le dossier sont faits de plumes mélangées et des chips en latex.
Zoe peut être revêtue de tissu, de microfibres, de simili-cuir et de cuir et possède des housses entièrement amovibles, sauf pour la version en cuir.
Le pied de Zoe est une base métallique pivotante à 4 branches, disponible en deux finitions. Il trouve sa place utile et idéale à la fois dans le salon domestique classique mais aussi dans les bureaux, les salles de réunion ou les halls d'hôtel.



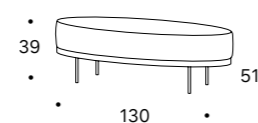

Il basamento in legno è disponibile nelle finiture legno Rovere Cenere, Canaletto e Noce Naturale o nei colori laccati a campionario.
Il cuscino è realizzato in poliuretano espanso densità 30 Kg/mc e viene bloccato sulla base di legno tramite del velcro. Il pouf può essere associato con il tavolino, la consolle, la madia o la libreria della collezione Beverly. Rivestibile in tessuto, microfibra, ecopelle e pelle ed è sempre completamente sfoderabile.

Piede di serie: in metallo H 18 cm verniciato Bronzo Vintage, optional nei colori laccati a campionario.

Misure: L cm 130 P cm 51 H cm 39

The wooden base is available in Rovere Cenere, Canaletto and Noce Naturale finishes or in lacquered colours as per sample book.
The cushion is made of polyurethane foam density 30 Kg/mc and is fixed on the wooden base by Velcro. The pouf can be combined with the coffee table, console, sideboard or bookcase from the Beverly collection. Beverly can be upholstered in fabric, microfibre, leatherette and leather and is always completely removable.

Standard feet: metal feet H 18 cm in Bronzo Vintage painted, optional in lacquered colours.

Measures: L cm 130 D cm 51 H cm 39

La base en bois est disponible en finition Rovere Cenere, Canaletto et Noce Naturale ou dans des échantillons de couleurs laquées. Le coussin est fait de mousse de polyuréthane de 30 kg/mc de densité et est bloqué sur la base en bois par du Velcro. Le pouf peut être combiné avec la table basse, la console, le buffet ou la bibliothèque de la collection Beverly. Beverly peut être revêtue de tissu, de microfibra, de simili-cuir et de cuir et est toujours entièrement amovible.

Pied standard: pied H 18 cm en métal avec finition Bronzo Vintage, en option en couleurs laquées.

Mesures: L cm 130 P cm 51 H cm 39

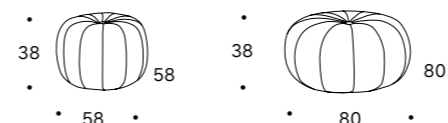

L'imbottitura è realizzata con perle di polistirene e fiocchi di fibra di espanso rivestiti con tessuto in policotone.
Disponibile in due misure, Bound può essere realizzato monocolore o fino ad un massimo di 4 colori coordinati.
Bound è rivestibile in tessuto, microfibra, ecopelle ed è sempre completamente sfoderabile.

**Misure: L cm 58 P cm 58 H cm 38
L cm 80 P cm 80 H cm 38**

The padding is made of polystyrene beads and staple fibres covered with poly-cotton fabric.
Available in two sizes. Bound can be made in one colour or up to a maximum of 4 matching colours.
Bound can be upholstered in fabric, microfiber, leatherette and is always completely removable.

**Measures: L cm 58 D cm 58 H cm 38
L cm 80 D cm 80 H cm 38**

Le rembourrage est composé de billes de polystyrène et de fibres discontinues recouvertes de tissu poly-coton.
Disponibile en deux tailles, Bound peut être réalisé en une seule couleur ou jusqu'à un maximum de 4 couleurs assorties.
La reliure peut être rembourrée de tissu, de microfibra, de simili-cuir et est toujours entièrement amovible.

**Mesures: L cm 58 P cm 58 H cm 38
L cm 80 P cm 80 H cm 38**

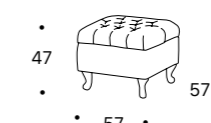

La struttura è realizzata in legno e multistrato. La seduta è realizzata in poliuretano espanso densità 35 kg/mc.
Il pouf Calvin è perfettamente abbinabile alla poltrona Bergere.
Calvin è rivestibile in pelle, ecopelle e microfibra sempre **non sfoderabile**.

Piede di serie: piede in legno H 15 cm finitura Rovere Cenere, disponibile nelle finiture Canaletto o Noce Naturale.

Misure: L cm 57 P cm 57 H cm 47

The structure is made of wood and plywood. The seat is made of polyurethane foam density 35 kg/mc.
Calvin pouf can be perfectly combined with Bergere armchair.
Calvin can be upholstered in leather, leatherette and microfibre, always with **non-removable** covers.

Standard feet: wooden feet H 15 cm Rovere Cenere finish, available in Canaletto or Noce Naturale finishes.

Measures: L cm 57 D cm 57 H cm 47

La structure est en bois. Le siège est fait de mousse de polyuréthane de densité 35 kg/mc.
Le pouf Calvin se combine parfaitement avec le fauteuil Bergere.
Calvin peut être revêtu de cuir, de similicuir et de microfibra, toujours avec des housses **non amovibles**.

Pied standard: pied en bois H 15 cm finition Rovere Cenere, disponible en finition Canaletto ou Noce Naturale.

Mesures: L cm 57 P cm 57 H cm 47

Denis - PAG. 59

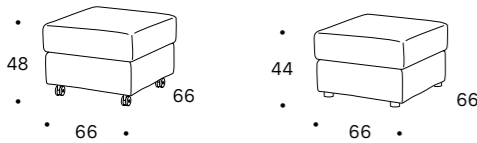

La struttura è realizzata in legno, rivestita con vellutino accoppiato.

La seduta è realizzata in poliuretano espanso densità 35 kg/mc.

Il pouf Denis può essere richiesto con le ruote in tinta argento o con il piede in plastica nera. A seconda del tipo di piede utilizzato varia l'altezza del pouf da 44 a 48 cm.

Denis è rivestibile in tessuto, microfibra, ecopelle e pelle ed è completamente sfoderabile tranne che nella versione in pelle.

Piede di serie: ruota H 8 cm tinta Argento o piede in plastica nera H 4 cm.

Misure: L cm 66 P cm 66 H cm 48 - con ruote
L cm 66 P cm 66 H cm 44 - con piedi

The structure is made of wood. The seat is made of polyurethane foam density 35 kg/mc. Denis pouf can be requested with silver coloured wheels or with black plastic feet. Depending on the foot used, the height of the pouff varies from 48 to 44 cm.

Denis can be upholstered in fabric, microfibre, leatherette and leather and is completely removable except for the leather version.

Standard feet: wheel H 8 cm Silver-coloured or black plastic feet H 4 cm.

Measures: L cm 66 D cm 66 H cm 48 - with weels
L cm 66 D cm 66 H cm 44 - with feet

La structure est en bois. Le siège est fait de mousse de polyuréthane de densité 35 kg/mc.

Le pouf Denis peut être demandé avec des roues de couleur argent ou avec un pied en plastique noir, selon le pied utilisé, la hauteur du pouf varie de 48 à 44 cm.

Denis peut être revêtu de tissu, de microfibre, de simili-cuir et de cuir et est entièrement amovible, sauf pour la version en cuir.

Pied standard: roue H 8 cm pied en plastique Argenté ou noir H 4 cm

Mesures: L cm 66 P cm 66 H cm 48 - avec roues
L cm 66 P cm 66 H cm 44 - avec pieds

Fly - PAG. 58

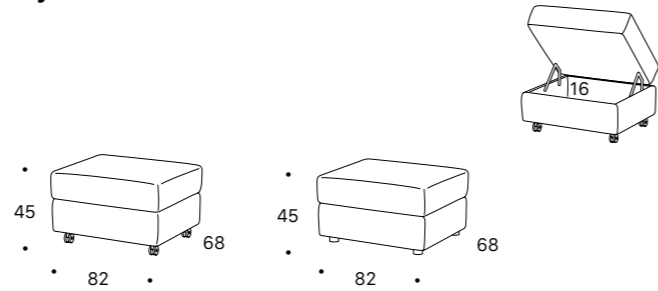

La struttura è realizzata in legno, rivestita con vellutino accoppiato.

La seduta è realizzata in poliuretano espanso densità 25 kg/mc.

Il pouf Fly può essere richiesto con le ruote in tinta argento o con il piede in legno colore Bronzo Vintage.

Il cuscino di seduta si solleva facilmente tramite un meccanismo a molla, scoprendo un capiente vano interno da 59x74 H 16 cm. Fly è rivestibile in tessuto, microfibra, ecopelle e pelle ed è completamente sfoderabile.

Piede di serie: ruota H 8 cm tinta Argento o piede in legno verniciato 021 Marrone Caffè.

Misure: L cm 82 P cm 68 H cm 45

The structure is made of wood. The seat is made of polyurethane foam density 25 kg/mc.

Fly pouf can be requested with silver coloured wheels or with a wooden feet in Bronzo Vintage colour.

The seat cushion is easily lifted by a spring mechanism, giving access to a large internal compartment of 59x74 H 16 cm.

Fly can be upholstered in fabric, microfibre, leatherette and leather and is completely removable.

Standard feet: H 8 cm Silver-coloured wheel or feet in 021 Marrone Caffè lacquered wood.

Measures: L cm 82 D cm 68 H cm 45

La structure est en bois. Le siège est fait de mousse de polyuréthane d'une densité de 25 kg/mc.

Le pouf Fly peut être demandé avec les roues de couleur argent ou avec le pied en bois de couleur Bronzo Vintage.

Le coussin du siège se soulève facilement au moyen d'un mécanisme à ressort, découvrant un grand compartiment interne de 59x74 H 16 cm.

La mouche peut être recouverte de tissu, de microfibre, de cuir écologique et de cuir et est entièrement amovible.

Pied standard: H 8 cm roue H Argentée ou pied en bois peint en color 021 Marrone Caffè.

Mesures: L cm 82 P cm 68 H cm 45

Kip - PAG. 45

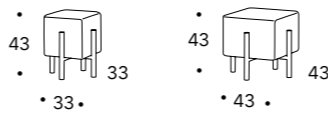

La struttura è realizzata in legno e lamiera. La seduta è realizzata in poliuretano espanso a doppia densità 30/30 morbido kg/mc.

Il pouf Kip si contraddistingue per l'elegante telaio in legno che lo rende un pouf di arredo funzionale ed esclusivo.

Kip è rivestibile in tessuto, microfibra, ecopelle e pelle ed è sempre completamente sfoderabile.

Piede di serie: telaio in legno finitura Rovere Cenere, disponibile come optional nelle finiture Canaletto o Noce Naturale.

Misure: L cm 33 P cm 33 H cm 43
L cm 43 P cm 43 H cm 43

The structure is made of wood and sheet metal.

The seat is made of polyurethane foam density 30/30 soft kg/mc.

Kip pouf stands out with an elegant wooden frame that makes it a functional and exclusive furnishing element.

Kip can be upholstered in fabric, microfibre, leatherette and leather and is always completely removable

Standard feet: wooden frame with Rovere Cenere finish, available in Canaletto or Noce Naturale finishes.

Measures: L cm 33 D cm 33 H cm 43
L cm 43 D cm 43 H cm 43

La structure est faite de bois et de tôle. Le siège est fait de mousse de polyuréthane de densité 30/30 soft kg/mc.

Le Kip pouf se distingue par son élégant cadre en bois qui en fait un pouf d'ameublement fonctionnel et exclusif.

Kip peut être revêtu de tissu, de microfibre, de simili-cuir et de cuir et est toujours entièrement amovible.

Pied standard: cadre en bois avec finition en Rovere Cenere, disponible en finition Canaletto ou Noce Naturale.

Mesures: L cm 33 P cm 33 H cm 43
L cm 43 P cm 43 H cm 43

Lupin - PAG. 54

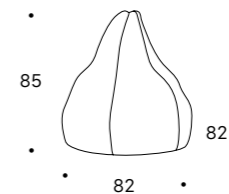

Anima interna realizzata con perle di polistirene racchiuse in una sacca contenitiva in tessuto policotone.

Disponibile in un'unica misura, si consiglia l'utilizzo solo di tessuti in tinta unita.

Lupin è rivestibile in tessuto, microfibra, ecopelle e pelle ed è sempre completamente sfoderabile.

Lupin è il pouf a sacco per eccellenza, comodo per giocare ai videogiochi, bello e divertente come soluzione d'arredo. Un pouf a forma di pera realizzato in polistirolo racchiuso in una sacca contenitiva.

Misure: L cm 82 P cm 82 H cm 85

Core made of polystyrene beads enclosed in a poly-cotton bag.

Available in one size only. We recommend to use plain fabrics pattern only.

Lupin can be upholstered in fabric, microfibre, leatherette and leather and is always completely removable.

Lupin is the pouf-bag par excellence, comfortable to play video games, beautiful and fun as a furnishing solution. A pear-shaped pouf made of polystyrene enclosed in a storage bag.

Measures: L cm 82 D cm 82 H cm 85

Noyau interne constitué de billes de polystyrène enfermées dans un sac contenant du TNT. Disponible en taille unique, nous recommandons l'utilisation de tissus unis uniquement.

Le lupin peut être revêtu de tissu, de microfibre, de simili-cuir et de cuir et est toujours entièrement amovible.

Lupin est le pouf-bag par excellence, confortable pour jouer aux jeux vidéo, beau et amusant comme solution d'ameublement. Un pouf en forme de poire en polystyrène enfermé dans un sac de rangement.

Mesures: L cm 82 P cm 82 H cm 85

Mitos - PAG. 51

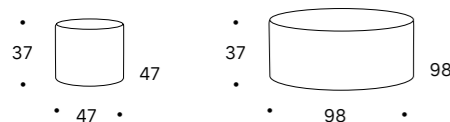

L'imbottitura è realizzata in poliuretano espanso a doppia densità 30/30 morbido Kg/mc.

Disponibile in due misure, Mitos è un'ottima soluzione di arredo che permette di avere sempre pronte delle comode sedute, e delle ottime soluzioni d'appoggio.

Mitos è rivestibile in tessuto, microfibra, ecopelle o pelle ed è sempre completamente sfoderabile.

Misure: L cm 47 P cm 47 H cm 37
L cm 98 P cm 98 H cm 37

The padding is made of double density polyurethane foam 30/30 soft Kg/mc. Available in two sizes. Mitos is an excellent furnishing solution that give you always two comfortable seats ready.

Mitos can be upholstered in fabric, microfibra, leatherette or leather and is always completely removable.

Measures: L cm 47 D cm 47 H cm 37
L cm 98 D cm 98 H cm 37

Le rembourrage est fait de mousse de polyuréthane double densité 30/30 soft Kg/mc.

Disponibile en deux tailles, Mitos est une excellente solution d'ameublement qui vous permet d'avoir toujours des sièges confortables à portée de main.

Les mitos peuvent être rembourrées en tissu, en microfibra, en simili-cuir ou en cuir et sont toujours entièrement amovibles.

Mesures: L cm 47 P cm 47 H cm 37
L cm 98 P cm 98 H cm 37

Porter - PAG. 56

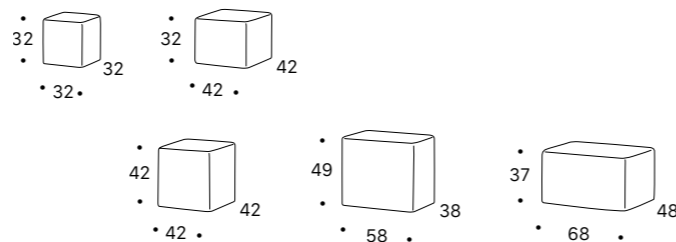

I pouf sono realizzati da un blocco unico di poliuretano espanso a doppia densità 30/30 morbido Kg/mc.

Disponibili in cinque diverse misure che si possono richiedere singolarmente o in più pezzi per creare degli esclusivi giochi di volumi e colori.

Porter è rivestibile in tessuto, microfibra, ecopelle e pelle ed è sempre completamente sfoderabile.

Misure: L cm 32 P cm 32 H cm 32
L cm 42 P cm 42 H cm 32
L cm 42 P cm 42 H cm 42
L cm 58 P cm 38 H cm 49
L cm 68 P cm 48 H cm 37

The poufs are made from a single piece of double density soft polyurethane foam 30/30 Kg/mc.

Available in five different sizes that can be requested individually or in several sizes to create games with different dimensions or colours.

Porter can be upholstered in fabric, microfibra, leatherette and leather and is always completely removable.

Measures: L cm 32 D cm 32 H cm 32
L cm 42 D cm 42 H cm 32
L cm 42 D cm 42 H cm 42
L cm 58 D cm 38 H cm 49
L cm 68 D cm 48 H cm 37

Les poufs sont fabriqués à partir d'un seul bloc de mousse de polyuréthane de double densité 30/30 soft Kg/mc.

Disponibile en cinq tailles différentes qui peuvent être demandées individuellement ou en plusieurs morceaux pour créer des jeux exclusifs de volumes et de couleurs.

Porter peut être revêtu de tissu, de microfibra, de simili-cuir et de cuir et est toujours entièrement amovible.

Measures: L cm 32 P cm 32 H cm 32
L cm 42 P cm 42 H cm 32
L cm 42 P cm 42 H cm 42
L cm 58 P cm 38 H cm 49
L cm 68 P cm 48 H cm 37

Rik - PAG. 44

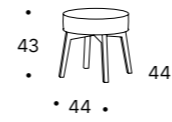

La struttura è realizzata in legno. La seduta è realizzata in poliuretano espanso densità 30 kg/mc.

Le linee del pouf Rik richiamano le forme degli sgabelli dal gusto nordico.

Rik è rivestibile in tessuto, microfibra, ecopelle e pelle ed è sempre completamente sfoderabile.

Piede di serie: piede in legno H 32 cm finitura Rovere Cenere, disponibile anche nelle finiture Canaletto o Noce Naturale.

Misure: L cm 44 P cm 44 H cm 43

The structure is made of wood. The seat is made of polyurethane foam density 30 kg/mc.

The Rik pouf's lines recall the shapes of Nordic style stools.

Rik can be upholstered in fabric, microfibra, leatherette and leather and is always completely removable.

Standard feet: wooden feet H 32 cm Rovere Cenere finish, available in Canaletto or Noce Naturale finishes.

Measures: L cm 44 D cm 44 H cm 43

La structure est en bois. Le siège est fait de mousse de polyuréthane de densité 30 kg/mc.

Les lignes du pouf Rik rappellent les formes des tabourets de style nordique.

Rik peut être revêtu de tissu, de microfibra, de simili-cuir et de cuir et est toujours entièrement amovible.

Pied standard: pied en bois H 32 cm avec finition en Rovere Cenere, disponible en finition Canaletto ou Noce Naturale.

Mesures: L cm 44 P cm 44 H cm 43

Ronny - PAG. 60

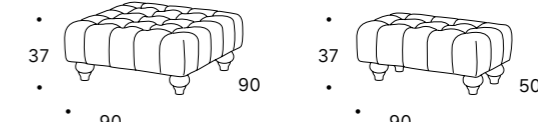

La struttura è realizzata in legno e multistrato. La seduta è realizzata in poliuretano espanso a doppia densità 30/50 kg/mc.

Il pouf è disponibile in due misure entrambe realizzate con l'elegante lavorazione con impuntura.

Ronny è rivestibile in pelle, ecopelle e microfibra sempre **non sfoderabile**.

Piede di serie: piede in legno H 14 cm finitura Rovere Cenere, disponibile anche nelle finiture Canaletto o Noce Naturale.

Misure: L cm 90 P cm 90 H cm 37
L cm 90 P cm 50 H cm 37

The structure is made of wood and plywood. The seat is made of polyurethane foam with double density 30/50 kg/mc.

The pouf is available in two sizes, both made with an elegant stitching work.

Ronny can be upholstered in leather, leatherette and microfibra, always with **non-removable** covers.

Standard feet: wooden feet H 14 cm Rovere Cenere finish, available in Canaletto or Noce Naturale finishes.

Measures: L cm 90 D cm 90 H cm 37
L cm 90 D cm 50 H cm 37

La structure est faite de bois et de contreplaqué. Le siège est en mousse de polyuréthane à double densité 30/50 kg/mc.

Le pouf est disponible en deux tailles, toutes deux réalisées avec d'élégantes coutures.

Ronny peut être revêtu de cuir, de simili cuir et de microfibra, toujours avec des housses **non amovibles**.

Pied standard: pied en bois H 14 cm avec finition en Rovere Cenere, disponible en finition Canaletto ou Noce Naturale.

Mesures: L cm 90 P cm 90 H cm 37
L cm 90 P cm 50 H cm 37

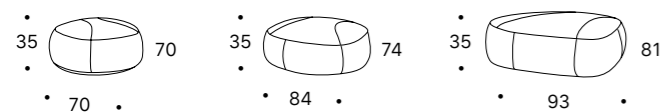

L'imbottitura è realizzata con un mix di perle di polistirene e chips di lattice rivestiti con tessuto in policotone.
Disponibile in tre misure, Sassi è caratterizzato dalla cucitura superiore sempre rifinita con un canneté di colore antracite.
Sassi è rivestibile in tessuto, microfibra, ecopelle ed è sempre completamente sfoderabile.

Misure: L cm 70 P cm 70 H cm 35
L cm 84 P cm 74 H cm 35
L cm 93 P cm 81 H cm 35

The padding is made with a mix of polystyrene beads and latex chips covered with poly-cotton fabric.
Available in three sizes, Sassi is characterized by the upper stitching always finished with an anthracite coloured canneté.
Sassi can be covered in fabric, microfibre, leatherette and is always completely removable.

Measures: L cm 70 D cm 70 H cm 35
L cm 84 D cm 74 H cm 35
L cm 93 D cm 81 H cm 35

Le rembourrage est composé d'un mélange de billes de polystyrène et de copeaux de latex recouverts de tissu poly-coton.
Disponibile en trois tailles, Sassi se caractérise par la surpiqûre supérieure toujours finie avec un canneté de couleur anthracite.
Sassi peut être recouvert de tissu, microfibre, similcuir et est toujours complètement déhoussable.

Mesures: L cm 70 P cm 70 H cm 35
L cm 84 P cm 74 H cm 35
L cm 93 P cm 81 H cm 35

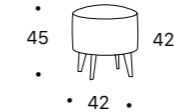

La struttura è realizzata in legno e multistrato. La seduta è realizzata in poliuretano espanso densità 40 kg/mc.
Tiger è rivestibile in tessuto, microfibra, ecopelle e pelle ed è completamente sfoderabile tranne che nella versione in pelle.

Piede di serie: piede in metallo tagliato al laser H 18,5 cm finitura Indian Brown, optional disponibile anche nel colore 013 Grigio Piombo.

Misure: L cm 42 P cm 42 H cm 45

The structure is made of wood and plywood.
The seat is made of polyurethane foam density 40 kg/mc.
Tiger can be upholstered in fabric, microfibre, leatherette and leather and is completely removable except for the leather version.

Standard feet: laser-cut metal feet H 18.5 cm Indian Brown finish, optional also available in 013 Grigio Piombo.

Measures: L cm 42 D cm 42 H cm 45

La structure est faite de bois et de contreplaqué.
Le siège est fait de mousse de polyuréthane de densité 40 kg/mc.
Tiger peut être revêtu de tissu, de microfibre, de similcuir et de cuir et est entièrement amovible, sauf pour la version en cuir.

Pied standard: pied en métal découpé au laser H 18,5 cm finition Indian Brown, en option également disponible en Grigio Piombo 013.

Mesures: L cm 42 P cm 42 H cm 45

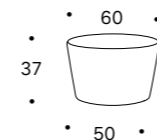

L'imbottitura è realizzata in poliuretano espanso densità a doppia densità 30/30 morbido Kg/mc.
Disponibile in un'unica misura, Tod si caratterizza per la forma conica.
Tod è rivestibile in tessuto, ecopelle, microfibra o pelle, sempre completamente sfoderabile. Il pouf Tod è sicuramente una seduta alternativa ai classici pouf cilindrici, ed anche un comodo appoggio per vestiti quando alla sera ci si spoglia e non si sa mai dove mettere la biancheria. Comodo per giocare, facile da spostare perché leggero.

Misure: L cm 60 P cm 60 H cm 37

The padding is made of double density soft polyurethane foam 30/30 Kg/mc.
Available in one size only, Tod is characterized by its conical shape.
Tod can be upholstered in fabric, leatherette, microfibre or leather, always completely removable. The Tod pouf is definitely an alternative seat to the classic cylindrical poufs, and also a comfortable support for clothes when you undress in the evening and you never know where to put the stuff. Comfortable to play, easy to move because it is light.

Measures: L cm 60 D cm 60 H cm 37

Le rembourrage est fait de mousse de polyuréthane double densité 30/30 Kg/mc souple.
Disponibile en une seule taille, le Tod se caractérise par sa forme conique.
Tod peut être revêtu de tissu, d'écocuir, de microfibre ou de cuir, toujours entièrement amovible. Le pouf Tod est définitivement un siège alternatif aux poufs cylindriques classiques, et aussi un support confortable pour les vêtements lorsque vous vous déshabillez le soir et que vous ne savez jamais où mettre les affaires. Confortable à jouer, facile à déplacer car léger.

Mesures: L cm 60 P cm 60 H cm 37

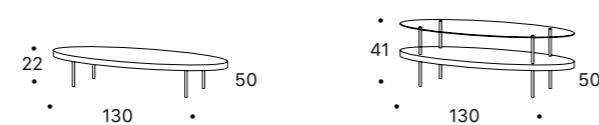

Il piano in legno è disponibile nelle finiture legno Rovere Cenere, Canaletto e Noce Naturale o nei colori laccati a campionario. Beverly è caratterizzato dall'elegante forma ovale ben definita con un richiamo al gusto classico, ed è disponibile anche nella versione con il doppio piano, di cui quello superiore sempre in vetro Extra Chiaro o Grigio Fumè.

Piede di serie: piede in metallo H 18 cm verniciato Bronzo Vintage, optional nei colori laccati a campionario.

Misure: L cm 130 P cm 50 H cm 22
L cm 130 P cm 50 H cm 41

The wooden top is available in Rovere Cenere, Canaletto and Noce Naturale finishes or in lacquered colours as sample book. Beverly is characterized by its elegant, well-defined oval shape with a reference to classic taste, and is also available in the version with the double top of which the top one always in Extra Clear or Grey Smoked glass.

Standard feet: metal feet H 18 cm in Bronzo Vintage painted, optional in lacquered colours.

Measures: L cm 130 D cm 50 H cm 22
L cm 130 D cm 50 H cm 41

Le plateau en bois est disponible dans les finitions Rovere Cenere, Canaletto et Noce Naturale ou dans des couleurs laquées provenant de la collection d'échantillons. Beverly se caractérise par sa forme ovale élégante et bien définie qui fait référence au goût classique. Elle est également disponible dans la version avec double couvercle en verre dont le premier toujours Extra Clair ou en verre Gris Fumé.

Pied standard: pied H 18 cm en métal avec finition Bronzo Vintage, en option en couleurs laquées.

Mesures: L cm 130 P cm 50 H cm 22
L cm 130 P cm 50 H cm 41

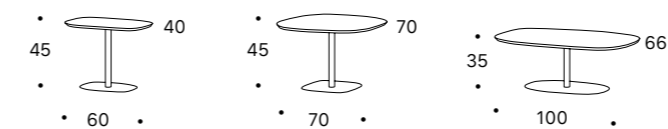

Il piano è realizzato in MDF pantografato con bordo a 45°, disponibile nelle finiture colori laccati a campionario. Nel caso siano richiesti i piedi con dei colori laccati si specifica che il piano viene realizzato sempre nello stesso colore. Elisse, disponibile in tre misure diverse, è caratterizzato da un design essenziale che ben si adatta a qualsiasi ambiente.

Piede di serie: basamento in metallo verniciato Bronzo Vintage, optional nei colori laccati a campionario.

Misure: L cm 60 P cm 40 H cm 45
L cm 70 P cm 70 H cm 45
L cm 100 P cm 66 H cm 35

The top is made of pantographed MDF with 45° edge, available in the lacquered colours in samples. In case lacquered feet are required, it is specified that the top is always made in the same colour. Elisse, available in three different sizes, is characterized by an essential design that adapts well to any environment.

Standard feet: in Bronzo Vintage painted metal base, optional in lacquered colours.

Measures: L cm 60 D cm 40 H cm 45
L cm 70 D cm 70 H cm 45
L cm 100 D cm 66 H cm 35

Le plateau est en MDF pantographié avec un bord à 45°, disponible dans les couleurs laquées en échantillons. Dans le cas où des pieds laqués sont nécessaires, il est précisé que le dessus est toujours de la même couleur. Elisse, disponible en trois tailles différentes, se caractérise par un design essentiel qui s'adapte bien à tout environnement.

Pied standard: base en métal en Bronzo Vintage peint, en option en couleurs laquées.

Mesures: L cm 60 P cm 40 H cm 45
L cm 70 P cm 70 H cm 45
L cm 100 P cm 66 H cm 35



Il piano realizzato in MDF pantografato con bordo a 45° è disponibile nelle finiture dei colori laccati a campionario o in pietra Gray Stone solo nella misura da 80 cm.

Evan è un tavolino disponibile in due diverse misure che si differenziano per le dimensioni di diametro e altezza.

Piede di serie: basamenti in legno massello finitura Rovere Cenere, disponibile nelle finiture Canaletto o Noce Naturale.

Misure: L cm 80 P cm 80 H cm 42
L cm 130 P cm 130 H cm 32

The top is made of pantographed MDF with 45° edge and is available in lacquered colours or in Gray Stone only in the 80 cm size. Evan is an imposing coffee table to be placed in front of a living room thanks to its important shape. It is available in two different sizes that differ in diameter and height.

Standard feet: in solid wood base with Rovere Cenere finish, available in Canaletto or Noce Naturale finishes.

Measures: L cm 80 D cm 80 H cm 42
L cm 130 D cm 130 H cm 32

Le plateau est en MDF pantographié avec un bord à 45° et est disponible dans des couleurs laquées ou en Gray Stone uniquement dans la taille 80 cm. Evan est une imposante table basse à placer devant un salon grâce à sa forme importante. Elle est disponible en deux tailles différentes qui se distinguent par leur diamètre et leur hauteur.

Pied standard: base en bois massif avec finition Rovere Cenere, disponible en finition Canaletto ou Noce Naturale.

Mesures: L cm 80 P cm 80 H cm 42
L cm 130 P cm 130 H cm 32

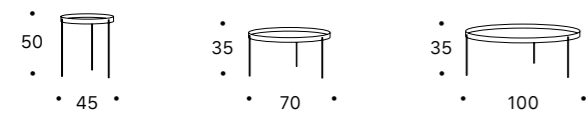

La struttura di Floyd è in metallo verniciato Bronzo Vintage. Il piano superiore può essere realizzato e richiesto con le varie finiture del legno, dei nobilitati o in pannelli di MDF con i colori laccati a campionario. Inoltre sui tavolini con diametro da 45 cm e da 70 cm può essere richiesto il piano in pietra Gray Stone.

Piede di serie: telaio in metallo verniciato Bronzo Vintage.

Misure: L cm 45 P cm 45 H cm 50
L cm 70 P cm 70 H cm 35
L cm 100 P cm 100 H cm 35

Floyd's frame is in Bonzo Vintage painted metal. The top can be made and requested with the various finishes of wood, melamine or MDF with lacquered colours. In addition, on coffee tables with a diameter of 45 cm and 70 cm, the Gray Stone top can be requested.

Standard feet: Bronzo Vintage painted metal frame.

Measures: L cm 45 D cm 45 H cm 50
L cm 70 D cm 70 H cm 35
L cm 100 D cm 100 H cm 35

Le cadre de Floyd est en métal peint Bronzo Vintage. Le plateau peut être réalisé et demandé avec les différentes finitions de bois, plaqué ou MDF avec les couleurs des échantillons laqués. En outre, sur les tables basses de 45 cm et 70 cm de diamètre, le plateau Gray Stone peut être demandé.

Pied standard: Cadre métallique peint en Bronzo Vintage.

Mesures: L cm 45 P cm 45 H cm 50
L cm 70 P cm 70 H cm 35
L cm 100 P cm 100 H cm 35

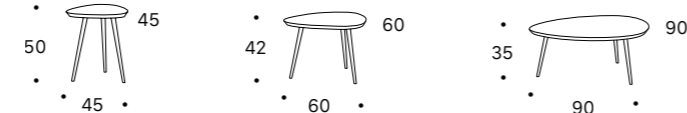

Tavolino dal design essenziale e moderno, disponibile in tre diverse misure. Le diverse altezze permettono di realizzare composizioni esclusive e sofisticate. Tavolino con gambe in legno, disponibile in diverse finiture. Il piano triangolare del tavolino è realizzato in MDF pantografato con bordo a 45° ed è disponibile nei colori laccati a campionario.

Piede di serie: piede in legno massello finitura Rovere Cenere, disponibile nelle finiture Canaletto, Noce Naturale o nei colori laccati a campionario.

Misure: L cm 45 P cm 45 H cm 50
L cm 60 P cm 60 H cm 42
L cm 90 P cm 90 H cm 35

Coffee tables with an essential and modern design, available in three different sizes. The different heights make it possible to create exclusive and sophisticated compositions. The top is made of pantographed MDF with 45° edge and is available in the finishes lacquered colours in samples.

Standard feet: in solid wood feet with Rovere Cenere finish, available in Canaletto, Noce Naturale or in lacquered finishes with samples.

Measures: L cm 45 D cm 45 H cm 50
L cm 60 D cm 60 H cm 42
L cm 90 D cm 90 H cm 35

Des tables basses au design essentiel et moderne, disponibles en trois tailles différentes. Les différentes hauteurs permettent de créer des compositions exclusives et sophistiquées. Le plateau est en MDF pantographié avec un bord à 45° et est disponible dans les couleurs de finition laquées en échantillons.

Pied standard: pied en bois massif avec finition en Rovere Cenere, disponible dans les finitions Canaletto, Noce Naturale ou laqué.

Mesures: L cm 45 P cm 45 H cm 50
L cm 60 P cm 60 H cm 42
L cm 90 P cm 90 H cm 35

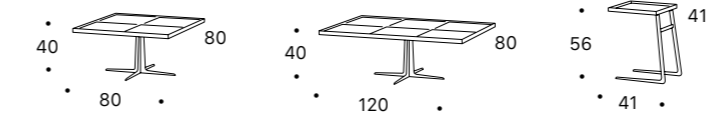

La struttura è in metallo verniciato. Il piano è realizzato in nobilitato lavorato a folding, disponibile nelle finiture a campionario come India, Asia, Spatolato, Terra. I tavolini Hugo possono essere personalizzati con l'applicazione di inserti posizionabili a piacimento. Gli inserti sono disponibili nelle finiture in vetro Extra Chiaro o Serigrafato 01 o in pannelli di MDF nei colori laccati a campionario.

Piede di serie: piede in metallo verniciato Bronzo Vintage, optional nei colori laccati a campionario.

Misure: L cm 80 P cm 80 H cm 40
L cm 120 P cm 80 H cm 40
L cm 41 P cm 41 H cm 56

The top is made of veneered folding work, available in the samples' finishes. Hugo coffee tables can be customized with the application of inserts that can be positioned as desired. The inserts are available in Extra Clear and Screen-Printed glass finishes or in MDF lacquered in the sample colours.

Standard feet: feet in Bronzo Vintage painted metal, optional in lacquered colours.

Measures: L cm 80 D cm 80 H cm 40
L cm 120 D cm 80 H cm 40
L cm 41 D cm 41 H cm 56

Le plateau est réalisé en pliage plaqué, disponible dans les finitions des échantillons. Les tables basses Hugo peuvent être personnalisées grâce à l'application d'inserts qui peuvent être positionnés à volonté. Les encarts sont disponibles dans des finitions en verre Extra Clair et Sérigraphié ou en MDF laqués dans les couleurs de l'échantillon.

Pied standard: pied en métal peint en Bronzo Vintage, en option en couleurs laquées.

Mesures: L cm 80 P cm 80 H cm 40
L cm 120 P cm 80 H cm 40
L cm 41 P cm 41 H cm 56

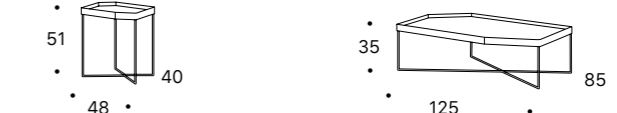

Struttura in metallo verniciato Bronzo Vintage. Il piano può essere realizzato in legno, in nobilitato o in MDF laccato disponibile nelle finiture a campionario. Nella misura da 40x48 cm è possibile richiedere il piano anche in pietra Gray Stone, mentre per la misura da 125x58 cm è possibile realizzare l'abbinata legno o nobilitato o laccato con la pietra Gray Stone.

Piede di serie: telaio in metallo verniciato Bronzo Vintage.

Misure: L cm 48 P cm 40 H cm 51
L cm 125 P cm 85 H cm 35

The frame is in Bronzo Vintage painted metal. The top can be made of wood, ennobled or lacquered MDF available in sample finishes. The Gray Stone finish is available only for the 40x48 cm size, while for the 125x58 cm size it is possible to create the combined wood, veneered or lacquered plus Gray Stone stone.

Standard feet: Bronzo Vintage painted metal frame.

Measures: L cm 48 D cm 40 H cm 51
L cm 125 D cm 85 H cm 35

Le cadre est en métal peint en Bronzo Vintage. Le plateau peut être en bois, ennobli ou laqué MDF disponible dans des finitions d'échantillons. La finition Gray Stone n'est disponible que pour le format 40x48 cm, tandis que pour le format 125x58 cm, il est possible de créer le bois assorti, plaqué ou laqué, plus la pierre Gray Stone.

Pied standard: Cadre métallique peint en Bronzo Vintage.

Mesures: L cm 48 P cm 40 H cm 51
L cm 125 P cm 85 H cm 35

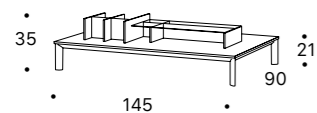

Struttura e piano vengono realizzati nelle finiture legno Rovere Cenere, Canaletto e Noce Naturale, a scelta.

Leonard viene fornito con un ripiano in vetro trasparente Extra Chiaro estraibile, mentre i vani portaoggetti in legno come la struttura.

Piede di serie: piede in legno massello con finitura Rovere Cenere, disponibile anche nelle finiture Canaletto o Noce Naturale.

Misure: L cm 145 P cm 90 H cm 35

Solid wood structure available in different finishes.

The wooden top is available in the wood finishes Rovere Cenere, Canaletto and Noce Naturale.

Leonard is supplied with an extractable shelf in Extra Clear transparent glass.

Standard feet: solid wood feet with Rovere Cenere finish, available in Canaletto or Noce Naturale finishes.

Measures: L cm 145 D cm 90 H cm 35

Structure en bois massif disponible en différentes finitions. Le plateau en bois est disponible dans les finitions Rovere Cenere, Canaletto et Noce Naturale.

Leonard est fourni avec une étagère extractible en verre transparent Extra Clair.

Pied standard: pied en bois massif avec finition Rovere Cenere, disponible en finition Canaletto ou Noce Naturale.

Mesures: L cm 145 P cm 90 H cm 35

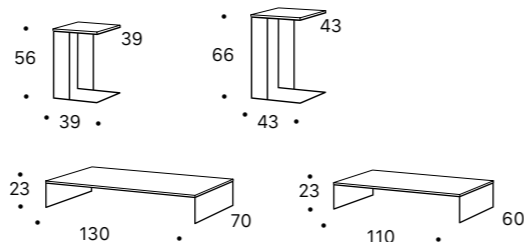

Struttura in metallo verniciato. Il piano può essere realizzato in legno: Rovere Cenere, Canaletto e Noce Nazionale; in nobilitato: India, Asia, Spatolato e Terra o laccato nelle finiture a campionario. Disponibili due misure di tavolini bassi e due misure di tavolini servetto.

Piede di serie: telaio in metallo verniciato Bronzo Vintage, disponibile anche nelle finiture colori laccati a campionario.

**Misure: L cm 39 P cm 39 H cm 56
L cm 43 P cm 43 H cm 66
L cm 110 P cm 60 H cm 23
L cm 130 P cm 70 H cm 23**

Painted metal structure. The top can be made in wood: Rovere Cenere, Canaletto and Noce Naturale; in melamine: India, Asia, Spatolato and Terra or lacquered in the sample finishes.

Two sizes of low tables and two sizes of service tables are available.

Standard feet: Bronzo Vintage painted metal frame, also available in lacquered finishes in samples.

**Measures: L cm 39 D cm 39 H cm 56
L cm 43 D cm 43 H cm 66
L cm 110 D cm 60 H cm 23
L cm 130 D cm 70 H cm 23**

Structure métallique peinte. Le plateau peut être réalisé en bois: Rovere Cenere, Canaletto et Noce Naturale; en mélamine: India, Asia, Spatolato et Terra ou laqué dans les finitions de l'échantillon.

Deux tailles de tables basses et deux tailles de tables de service sont disponibles.

Pied standard: Cadre métallique peint en Bronzo Vintage, également disponible en finition laquée en échantillons.

**Mesures: L cm 39 P cm 39 H cm 56
L cm 43 P cm 43 H cm 66
L cm 110 P cm 60 H cm 23
L cm 130 P cm 70 H cm 23**

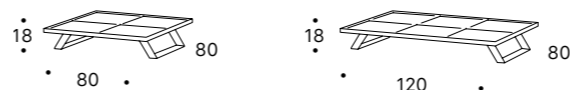

Struttura in metallo verniciato. Il piano è realizzato in nobilitato lavorato a folding, disponibile nelle finiture India, Asia, Terra e Spatolato.

I tavolini Otis possono essere personalizzati con l'applicazione di inserti posizionabili a piacimento. Gli inserti sono disponibili nelle finiture in vetro Extra Chiaro e Serigrafato 01 o in MDF laccato nei colori a campionario.

Piede di serie: piede in metallo verniciato Bronzo Vintage, optional nei colori laccati a campionario.

**Misure: L cm 80 P cm 80 H cm 18
L cm 120 P cm 80 H cm 18**

Painted metal structure. The top is made of veneered folding work, available in finishes India, Asia, Terra and Spatolato.

Otis coffee tables can be customized with the application of inserts that can be positioned as desired. The inserts are available in Extra-Clear and Screen-printed 01 glass finishes or MDF lacquered in the sample colours.

Standard feet: feet in Bronzo Vintage painted metal, optional in lacquered colours.

**Measures: L cm 80 D cm 80 H cm 18
L cm 120 D cm 80 H cm 18**

Structure métallique peinte. Le plateau est réalisé en pliage plaqué, disponible dans les finitions India, Asia, Terra ou Spatolato.

Les tables basses otis peuvent être personnalisées grâce à l'application d'inserts qui peuvent être positionnés à volonté. Les encarts sont disponibles dans des finitions en verre Extra-Clair et Sérigraphié 01 ou en MDF laqués dans les couleurs de l'échantillon.

Pied standard: pied en métal peint en Bronzo Vintage, en option en couleurs laquées.

**Mesures: L cm 80 P cm 80 H cm 18
L cm 120 P cm 80 H cm 18**

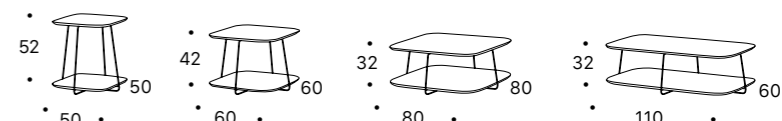

Struttura in metallo verniciato. I piani possono essere realizzati nelle finiture in legno Rovere Cenere, Canaletto o Noce Naturale.

Disponibile anche la versione con il piano laccato nei colori a campionario, abbinabile o in coordinato con il colore della struttura.

La collezione dei tavolini Plane propone quattro differenti misure.

Piede di serie: telaio in metallo verniciato Bronzo Vintage, disponibile anche nelle finiture colori laccati a campionario.

**Misure: L cm 50 P cm 50 H cm 52
L cm 60 P cm 60 H cm 42
L cm 80 P cm 80 H cm 32
L cm 110 P cm 60 H cm 32**

Painted metal structure. The tops can be made in Rovere Cenere, Canaletto or Noce Naturale wood finishes.

Available also the version with the lacquered top in sample colours, which can be matched or coordinated with the colour of the structure. The collection of Plane coffee tables offers four different sizes.

Standard feet: Bronzo Vintage painted metal frame, also available in lacquered finishes in samples.

**Measures: L cm 50 D cm 50 H cm 52
L cm 60 D cm 60 H cm 42
L cm 80 D cm 80 H cm 32
L cm 110 D cm 60 H cm 32**

Structure métallique peinte. Les plateaux peuvent être réalisés en Rovere Cenere, en Canaletto ou en Noce Naturale. Disponible également la version avec le dessus laqué dans des couleurs d'échantillon, qui peuvent être assorties ou coordonnées avec la couleur de la structure.

La collection de tables basses Plane propose quatre tailles différentes.

Pied standard: Cadre métallique peint en Bronzo Vintage, également disponible dans les finitions de couleur laquée.

**Mesures: L cm 50 P cm 50 H cm 52
L cm 60 P cm 60 H cm 42
L cm 80 P cm 80 H cm 32
L cm 110 P cm 60 H cm 32**

Roy - PAG. 72

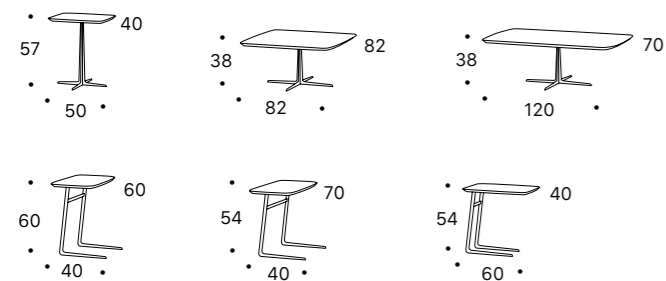

Struttura in metallo verniciato. I piani possono essere realizzati nelle finiture in legno Rovere Cenere, Canaletto o Noce Naturale. Disponibile anche la versione con il piano laccato nei colori a campionario, abbinabile o in coordinato con il colore del piede. La collezione dei tavolini Roy offre una vasta scelta di misure tra tavolini tradizionali e tavolini servetto.

Piede di serie: piede in metallo verniciato Bronzo Vintage, disponibile anche nelle finiture colori laccati a campionario.

Misure:	L cm 50	P cm 40	H cm 57
	L cm 82	P cm 82	H cm 38
	L cm 120	P cm 70	H cm 38
	L cm 40	P cm 60	H cm 59
	L cm 40	P cm 70	H cm 54
	L cm 60	P cm 40	H cm 54

Painted metal structure. The tops can be made in Rovere Cenere, Canaletto or Noce Naturale wood finishes. Available also the version with the lacquered top in sample colours, which can be matched or coordinated with the colour of the feet. The Roy coffee tables collection offers a wide choice of sizes between traditional and service tables.

Standard feet: feet in Bronzo Vintage lacquered metal, also available in lacquered finishes in samples.

Measures:	L cm 50	D cm 40	H cm 57
	L cm 82	D cm 82	H cm 38
	L cm 120	D cm 70	H cm 38
	L cm 40	D cm 60	H cm 60
	L cm 40	D cm 70	H cm 54
	L cm 60	D cm 40	H cm 54

Structure métallique peinte. Les plateaux peuvent être réalisés en Rovere Cenere, en Canaletto ou en Noce Naturale. Disponible également la version avec le dessus laqué dans des couleurs d'échantillon, qui peuvent être assorties ou coordonnées avec la couleur du pied. La collection de tables basses Roy offre un large choix de tailles entre les tables traditionnelles et les tables de service.

Pied standard: Pied métallique peint en Bronzo Vintage, également disponible dans les finitions de couleur laquée

Mesures:	L cm 50	P cm 40	H cm 57
	L cm 82	P cm 82	H cm 38
	L cm 120	P cm 70	H cm 38
	L cm 40	P cm 60	H cm 60
	L cm 40	P cm 70	H cm 54
	L cm 60	P cm 40	H cm 54

Terry - PAG. 84

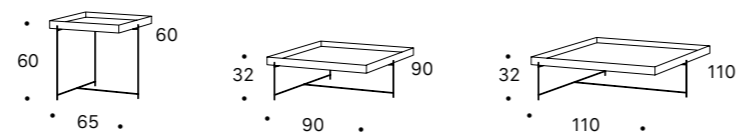

Struttura in metallo verniciato. Il piano è realizzato in nobilitato lavorato a folding, disponibile nelle finiture India, Asia, Terra e Spatolato. I tavolini Terry possono essere personalizzati con l'applicazione di inserti posizionabili a piacimento. Gli inserti sono disponibili nelle finiture in vetro Extra Chiaro e Serigrafato 01 oppure in MDF laccato nei colori a campionario.

Piede di serie: telaio in metallo verniciato Bronzo Vintage, optional nei colori laccati a campionario.

Misure:	L cm 65	P cm 60	H cm 60
	L cm 90	P cm 90	H cm 32
	L cm 110	P cm 110	H cm 32

Painted metal structure. The top is made of veneered folding work, available in the finishes India, Asia, Terra and Spatolato. Terry coffee tables can be customized with the application of inserts that can be positioned as desired. The inserts are available in extra-clear and screen-printed glass finishes or in MDF lacquered in the sample colours.

Standard feet: metal frame in Bronzo Vintage painted metal, optional in lacquered colours.

Measures:	L cm 65	D cm 60	H cm 60
	L cm 90	D cm 90	H cm 32
	L cm 110	D cm 110	H cm 32

Structure métallique peinte. Le plateau est réalisé en pliage plaqué, disponible dans les finitions India, Asia, Terra ou Spatolato. Les tables basses Terry peuvent être personnalisées grâce à l'application d'inserts qui peuvent être positionnés à volonté. Les encarts sont disponibles dans des finitions en verre extra-clair et sérigraphié ou en MDF laqués dans les couleurs de l'échantillon.

Pied standard: cadre métallique peint en Bronzo Vintage, en option en couleurs laquées.

Mesures:	L cm 65	P cm 60	H cm 60
	L cm 90	P cm 90	H cm 32
	L cm 110	P cm 110	H cm 32



VERSIONE LINEARE / LINEAR VERSION / VERSION LINÉAIRE

CON TELAIO METALLICO / WITH METAL FRAME / AVEC CADRE MÉTALLIQUE

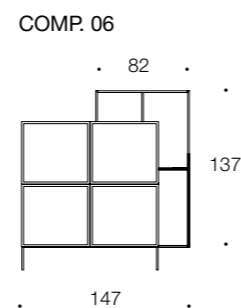
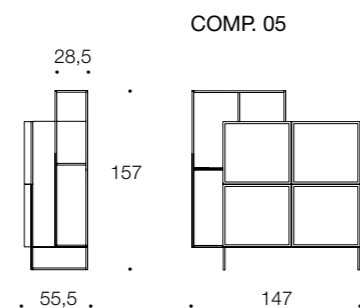
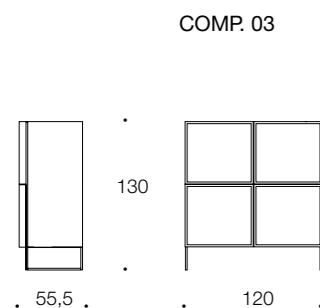
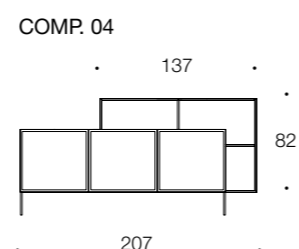
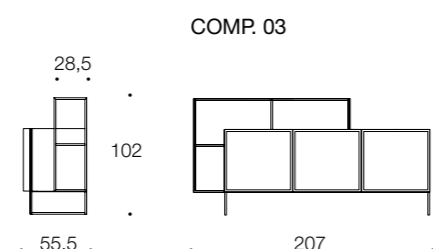
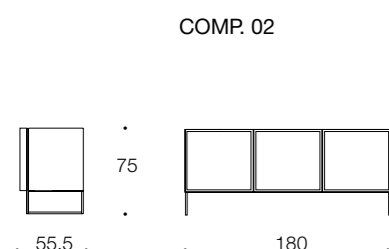
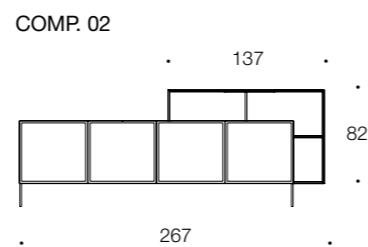
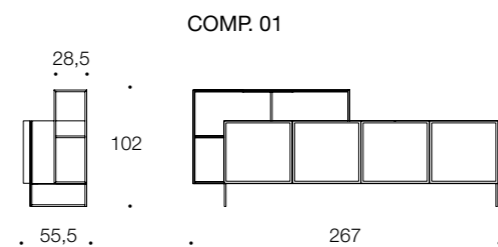
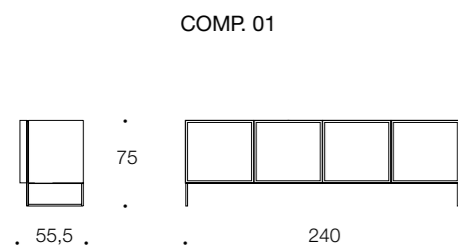

Alma è una collezione di madie disponibile in sei varianti nelle versioni lineare o con il telaio metallico.

Finitura struttura: nobilitato India, Asia, Spatolato o Terra.

Finitura inserti ante: Vetro serigrafato, carta da parati nelle varianti Losanga, Rombo e Cemento o pannello laccato in 24 varianti colore.

Finitura piedi e telaio: Bronzo Vintage di serie, optional laccato in 24 finiture colore.

Alma is a collection of sideboards available in six versions, linear or with metal frame.

Structure finish: melamine India, Asia, Spatolato o Terra.

Finish of door inserts: Silkscreen printed glass, wallpaper in Losanga, Rombo and Cemento or lacquered panel in 24 colour variations.

Feet and frame finish: Bronzo Vintage as standard, optional lacquered in 24 colour finishes.

Alma est une collection de buffets disponible en six variantes en version linéaire ou à cadre métallique.

Finition de la structure: melamine India, Asia, Spatolato ou Terra.

Finition de l'insert de la porte: verre sérigraphié, papier peint en Losanga, Rombo et Cemento ou panneau laqué en 24 couleurs.

Finition du pied et du cadre: Bronzo Vintage en standard, en option laqué en 24 couleurs.

MADIA

CONSOLE

LIBRERIA

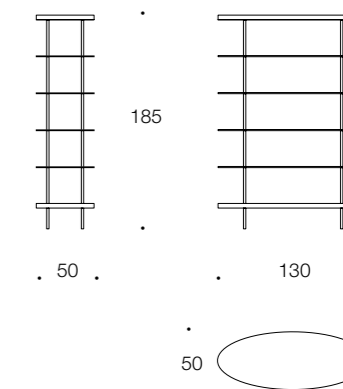
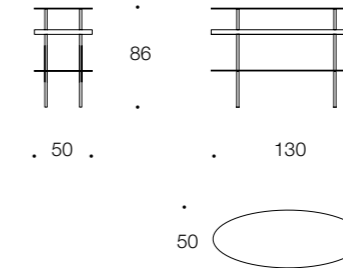
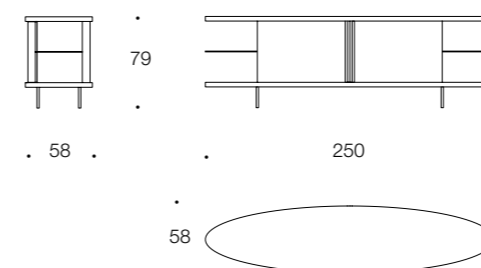

La madia, la console e la libreria Beverly possono essere abbinati e coordinati con i tavolini e il pouf della stessa collezione.

The Beverly sideboard, console and bookcase can be combined and coordinated with the coffee tables and the ottoman from the same collection.

Le buffet, la console et la bibliothèque Beverly peuvent être combinés et coordonnés avec les tables basses et le pouf de la même collection.

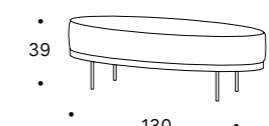
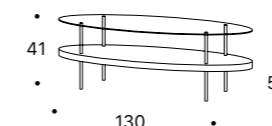
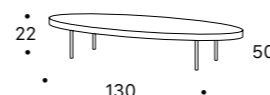

Beverly è una collezione composta da una madia, una consolle e una libreria.

Finitura struttura: in legno con finiture Noce Naturale, Canaletto e Rovere Cenere, o in laccato nei colori a campionario.

Finitura piani in vetro: Vetro Extra Chiaro, optional disponibile in Grigio Fumé.

Finitura piedi, telai e maniglia: in metallo verniciato Bronzo Vintage di serie, optional nei vari colori laccati.

Beverly is a collection consisting of a sideboard, a console and a bookcase.

Structure finish: in wood in the finishes Noce Naturale, Canaletto and Rovere Cenere, or lacquered in the colours of the range.

Glass tops finish: Extra Clear glass, optional available in Smoked Grey.

Feet, frames and handle finish: in Bronzo Vintage painted metal as standard, optional in the various lacquered colours.

Beverly est une collection composée d'un buffet, d'une console et d'une bibliothèque armoire, d'une console et d'une bibliothèque.

Finition de la structure: en bois dans les finitions Noce Naturale, Canaletto et Rovere Cenere, ou en laqué dans les différents couleurs de la gamme.

Finition des plateaux en verre: verre Extra Clair, disponible en option en Gris Fumé.

Finition des pieds, des cadres et des poignées: en métal peint Bronzo Vintage ou en option dans les différentes couleurs laquées.

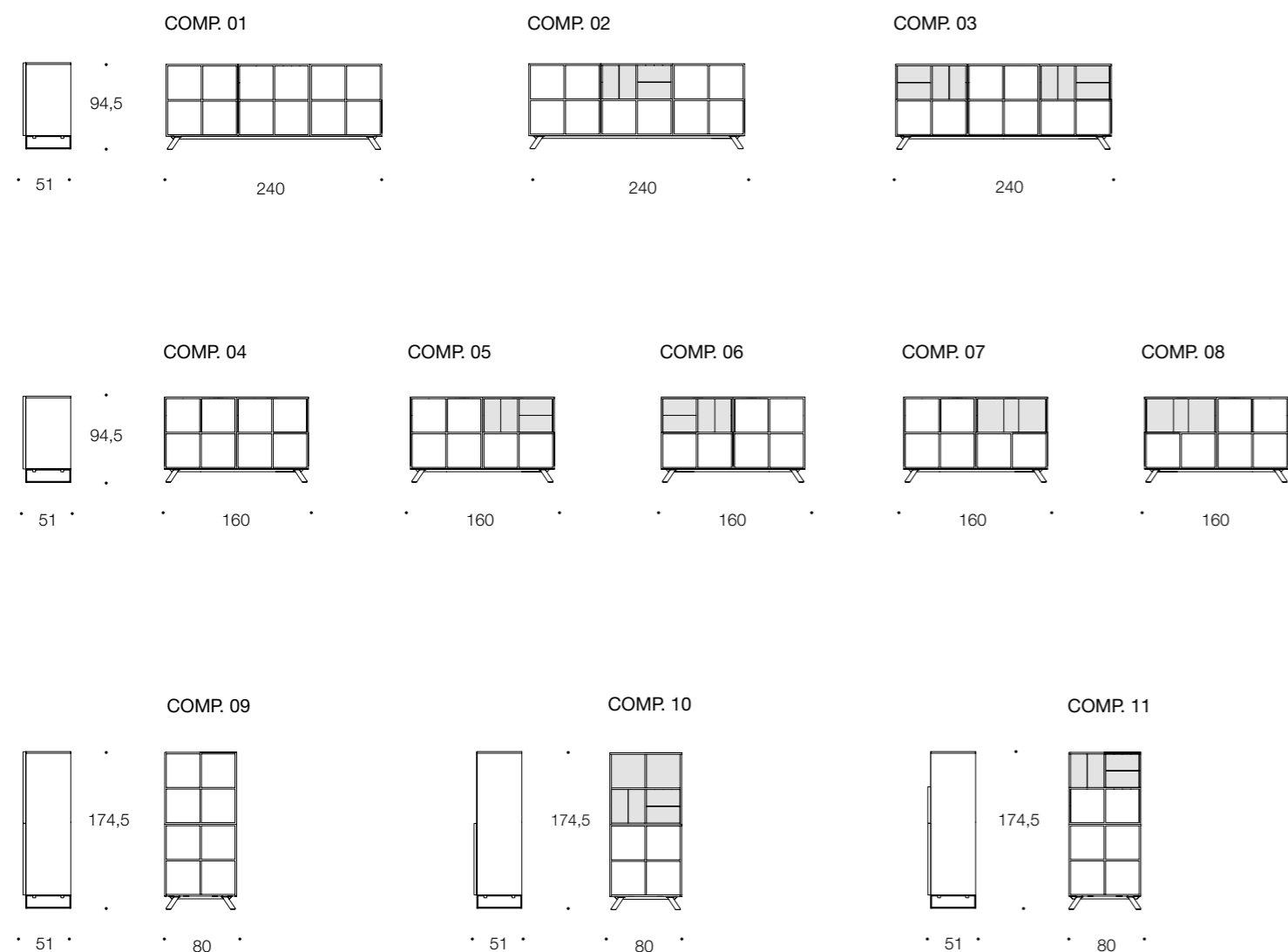

Kristen è una collezione di madie disponibile in versione lineare o versione verticale, entrambe con l'inserimento di vani a giorno. Gli elementi in metallo presenti nei vani a giorno sono realizzati di serie in Bronzo Vintage, optional possono essere richiesti nei vari colori laccati.

Finitura struttura: nobilitato India, Asia, Spatolato, Terra.

Finitura inserti ante: vetro serigrafato, carta da parati nelle varianti Losanga, Rombo e Cemento o pannello laccato in 24 varianti colore.

Finitura piedi: in metallo verniciato Bronzo Vintage.

Kristen is a collection of sideboards available in linear or vertical version, both with open compartments. The metal elements in the standard open compartments are made in Bronzo Vintage finish, optional can be requested in the various lacquered colours.

Structure finish: melamine India, Asia, Spatolato, Terra.

Door insert finish: silkscreen printed glass, wallpaper in Losanga, Rombo and Cemento or lacquered panel in 24 different colours.

Feet finish: in Bronzo Vintage painted metal.

VERSIONE CON PIEDI / VERSION WITH FEET / VERSION AVEC PIEDS

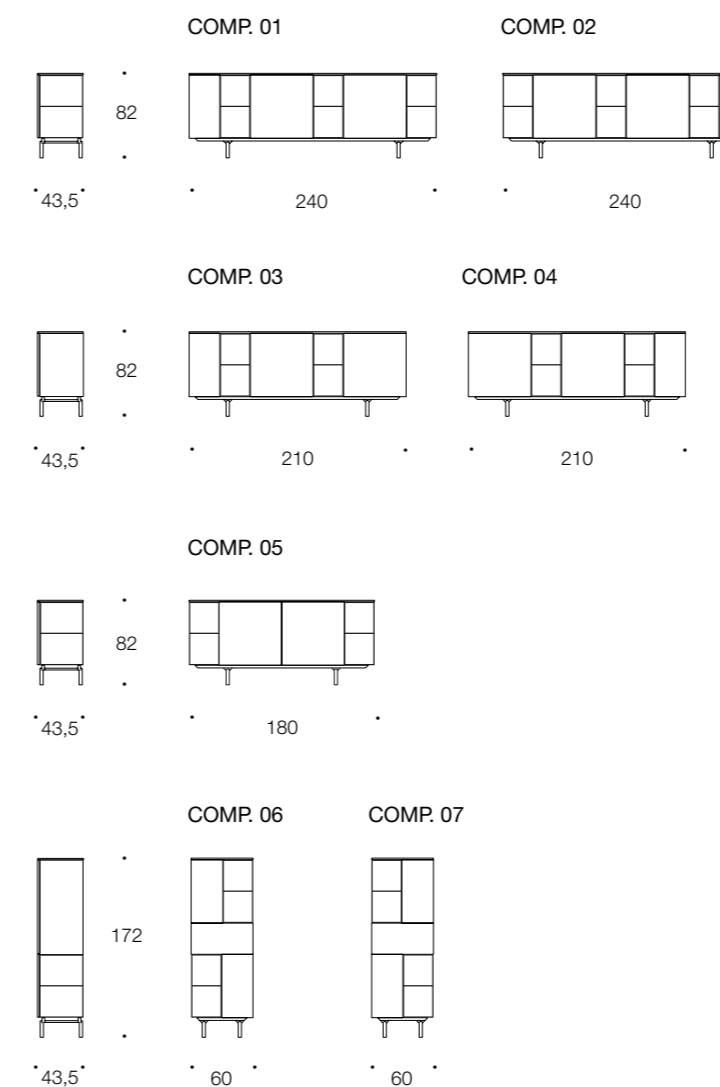

Lexia è una collezione mobili contenitori di varie dimensioni, disponibili nelle soluzioni a madia o libreria, entrambe con la possibilità di essere richieste nella versione con piede o sospesa.

Finitura struttura: in nobilitato India, Asia, Spatolato o Terra, oppure laccato nei 24 colori a campionario.

Finitura telai: laccato in 24 varianti colore.

Finitura piedi: in metallo verniciato Bronzo Vintage.

VERSIONE SOSPESA / SUSPENDED VERSION / VERSION SUSPENDUE

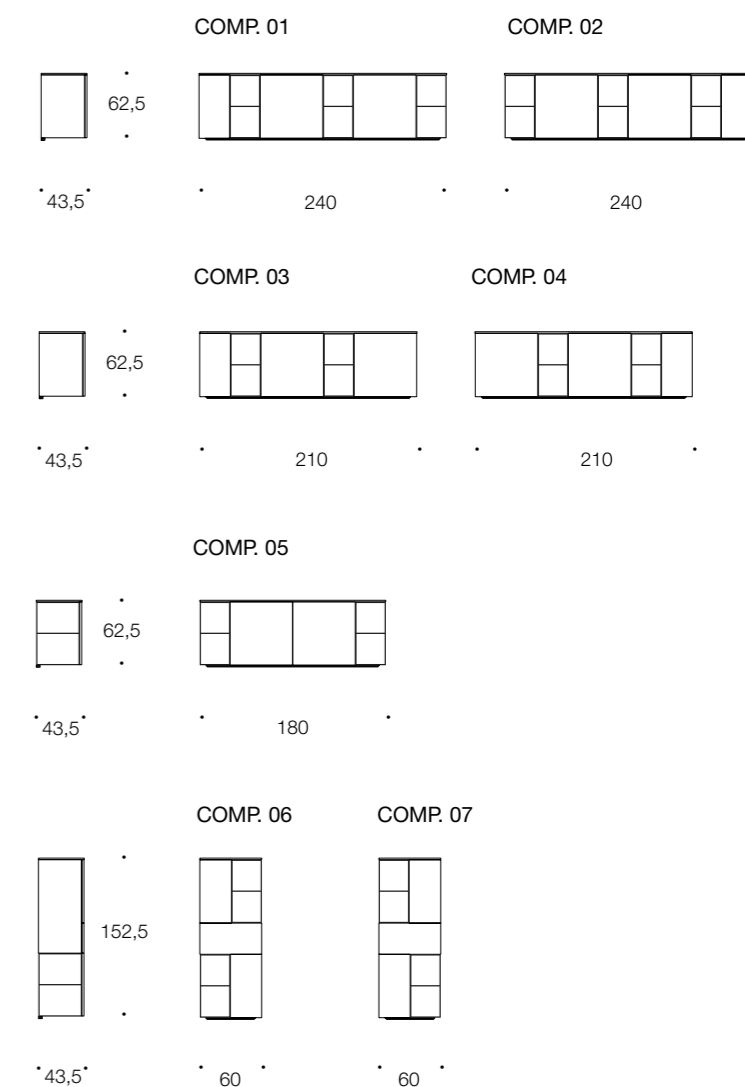

Lexia is a collection of storage units available as sideboard or bookcase solutions, both with the possibility to be requested with feet or in the suspended version.

Structure finish: melamine India, Asia, Spatolato, Terra or lacquered in 24 sample colours.

Frame finish: lacquered in 24 different colours.

Feet finish: in Bronzo Vintage painted metal.

Lexia est une collection de meubles de rangement disponibles en version buffet ou bibliothèque, avec la possibilité de les demander en version sur pied ou suspendue.

Finition de la structure: melamine India, Asia, Spatolato, Terra ou laqué en 24 couleurs.

Finition des cadres: laqué en 24 couleurs.

Finition du pied: en métal peint en Bronzo Vintage.

MADIA O PANCA / SIDE BOARD OR BEACH / BUFFET OR BANC

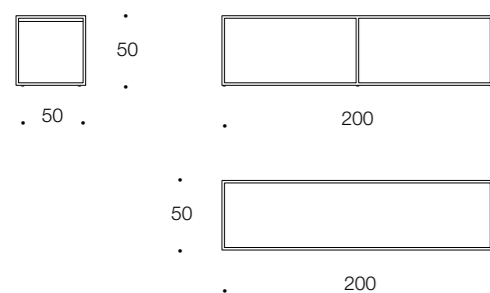

Minimal è una panca multifunzione disponibile in un'unica misura. Un elemento di arredo dalle linee essenziali che si inserisce elegantemente in tutti i contesti. È realizzata con un telaio in metallo a sezione quadrata e un piano che può essere richiesto nelle finiture nobilitato, laccato o in pietra Gray Stone.

Finitura telaio: in metallo a sezione quadra 2x2 cm verniciato Bronzo Vintage.

Finitura piano: nobilitato nelle finiture Asia, India, Spatolato, Terra o nei colori laccati a campionario con piano intero oppure in pietra Gray Stone con piano composto da due lastre.

Minimal is a bench, multifunction available in one size. A furniture element with essential lines that easily contextualises in all environments from the most refined to the most traditional. Minimal is made with a square section metal frame and a top that can be requested in melamine, lacquered or Gray Stone finishes.

Frame finish: in 2x2 cm square section metal painted Bronzo Vintage.

Top finish: melamine in Asia, India, Spatolato, Terra or the lacquered colours of the range finishes with a single top. Also available in Gray Stone with top divided into two slabs.

Minimal est un banc multifonctionnelle disponible en une seule taille. Un meuble aux lignes essentielles qui se contextualise facilement tous les environnements. Minimal est réalisé avec une structure en métal de section carrée et un plateau qui peut être demandé en mélamine, laque ou en pierre Gray Stone.

Finition du cadre: en métal de section carrée 2x2 cm peint en Bronzo Vintage.

Finition du plateau: melamine Asia, Inda, Spatolato, Terra ou dans les couleurs laquées de la gamme avec un seul sommet. également disponible en pierre Gray Stone avec le dessus divisé en deux dalles.

VERSIONE DA PARETE / WALL MOUNTING / MONTAGE MURAL

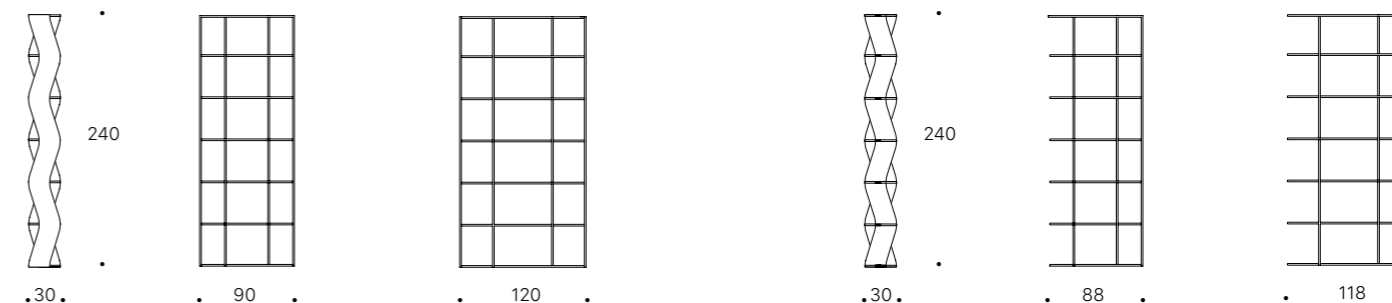

VERSIONE DA CENTRO STANZA / CENTER-ROOM VERSION / VERSION CENTRAL

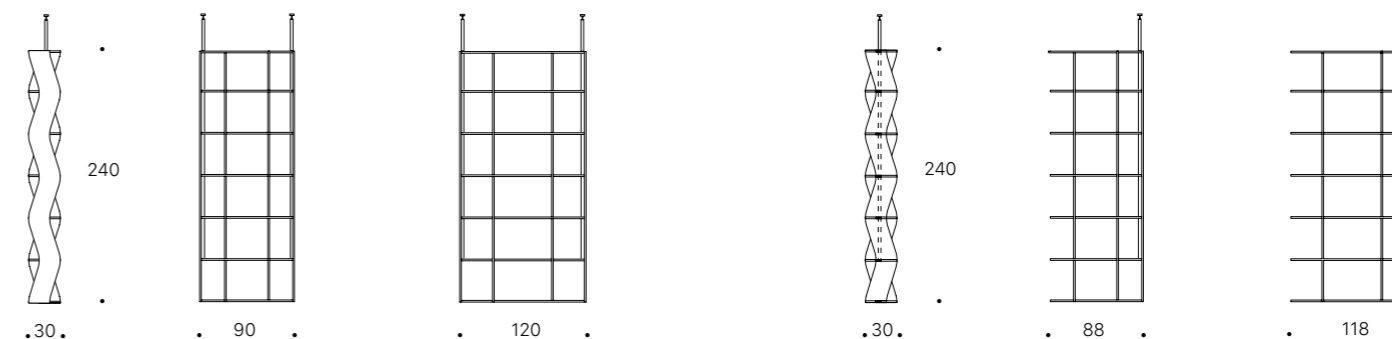

ELEMENTI TERMINALI
TERMINAL ELEMENTS
ÉLÉMENTS TERMINAUX

ELEMENTI INTERMEDI
INTERMEDIATE ELEMENTS
ÉLÉMENTS INTERMÉDIAIRES

Swing è una libreria disponibile in due misure e due versioni: da parete o da centro stanza. Grazie alla combinazione dei moduli terminali ed intermedi si possono sviluppare una serie di composizioni delle lunghezze desiderate.

Finitura struttura: realizzata in nobilitato Asia, India, Spatolato, Terra o Laccato nei 24 colori.

Pali telescopici per versione da centro stanza: realizzati in metallo, verniciato Bronzo Vintage con le finiture nobilitate, mentre nella versione laccata prendono lo stesso colore della struttura.

Swing is a bookcase available in two sizes and two versions: wall mounted or free standing. Thanks to the combination of end and intermediate modules a series of compositions of the desired lengths can be developed.

Structure finish: melamine in Asia, India, Spatolato, Terra or lacquered in the various colours of the range.

Telescopic poles for center-room version: in Bronzo Vintage lacquered metal when the melamine finishes are used, or lacquered in the same colour as the structure.

Swing est une bibliothèque disponible en deux tailles et en deux versions: murale ou centrale. Grâce à la combinaison de modules finaux et intermédiaires, il est possible de développer une série de compositions de la longueur souhaitée.

Finition de la structure: melamine Asia, Inda, Spatolato, Terra ou laqué dans des couleurs de la gamme.

Poteaux télescopiques pour version centrale: en métal laqué Bronze Vintage avec les finitions melamine, tandis que en version laquée prend la même couleur que la structure.

Materiali e finiture

Nobilitati / Melamine / Mélamine



India



Asia



Spatolato

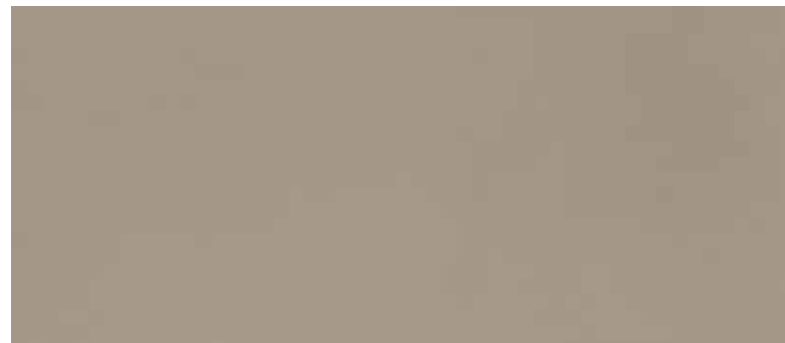

Terra

Essenze legno / Wood finishes / Finitions du bois



Noce Naturale



Noce Canaletto



Rovere Cenere

Vetri / Glass / Verre



Extra Chiaro



Grigio Fumé



Serigrafato 01

Metalli / Metals / Métaux



Bronzo Vintage



Indian Brown



Alluminio Opaco

Pietra / Stone / Pierre



Gray Stone

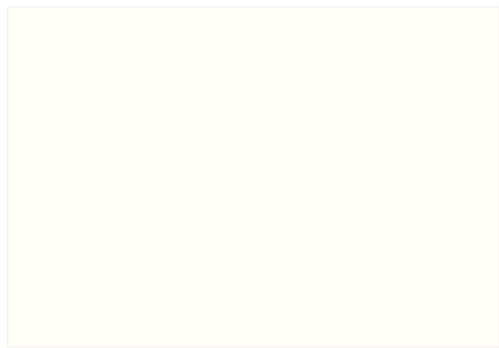

010 Bianco Ghiaccio



011 Bianco Perla



015 Beige Sabbia

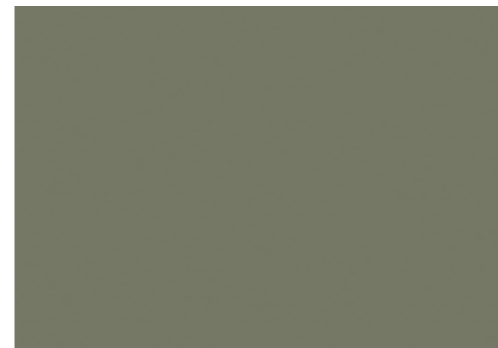

060 Verde Salvia



050 Verde Muschio



055 Verde Bottiglia

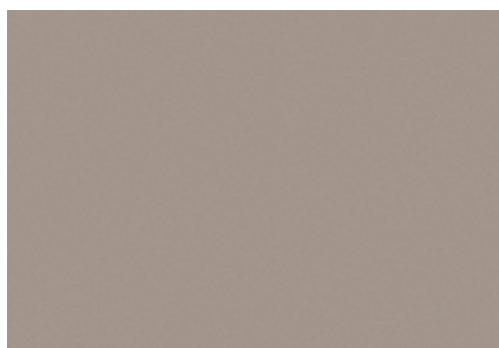

016 Grigio Pietra

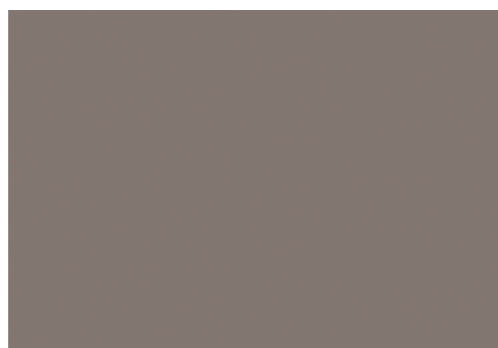

051 Grigio Tortora

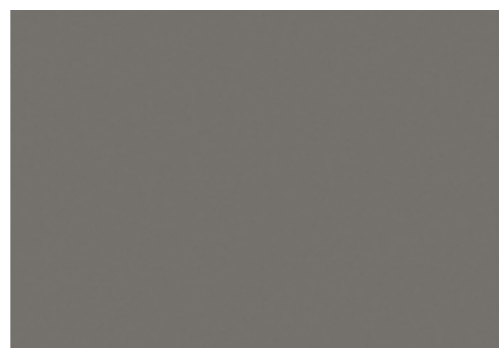

012 Grigio Titanio



054 Grigio Ottanio



020 Blu Oceano

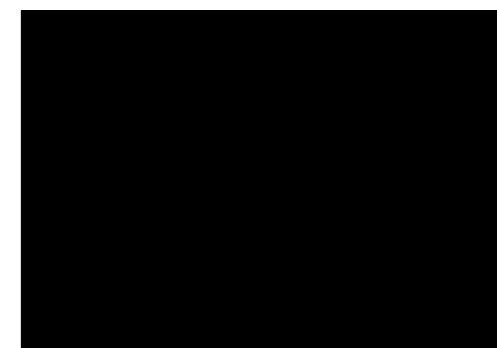

014 Nero Vesuvio

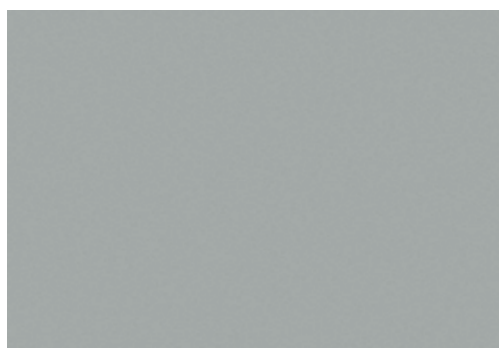

018 Azzurro Nuvola



053 Grigio Natura



052 Grigio Seta



061 Rosso Porpora



057 Arancio Mattone



019 Arancio Tramonto



013 Grigio Piombo

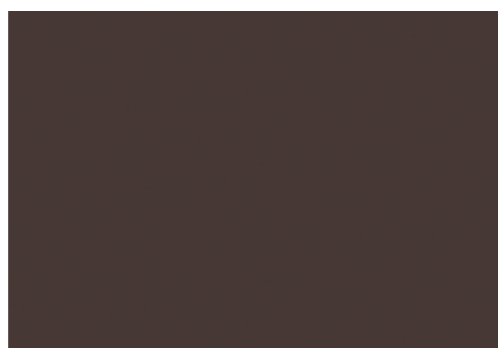

058 Grigio Tabacco

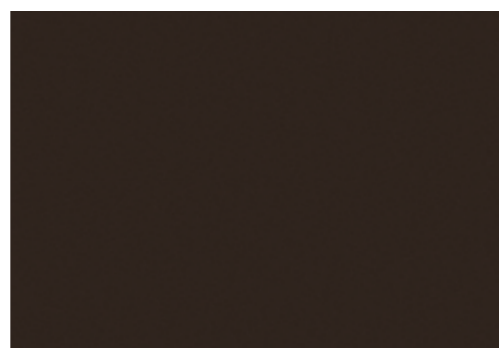

021 Marrone Caffé



059 Giallo Senape

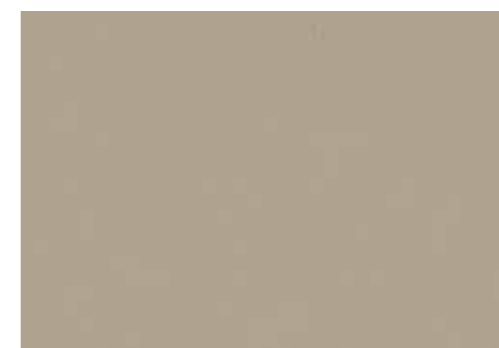

017 Grigio Salvia



056 Rosa Antico

Madia ALMA



Carta Parati Losanga 01

Madia KRISTEN

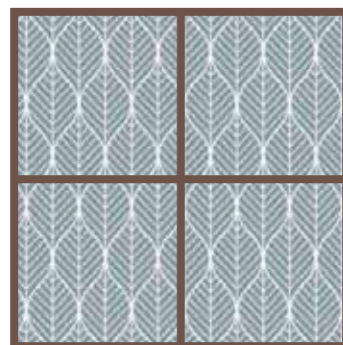

Carta Parati Losanga 01

Madia ALMA



Carta Parati Rombo 01

Madia KRISTEN



Carta Parati Rombo 01

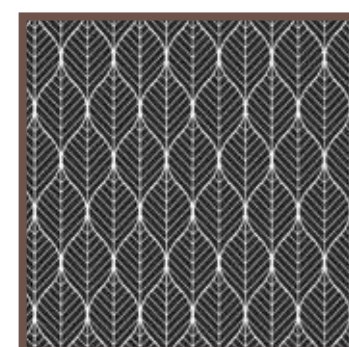

Carta Parati Losanga 02

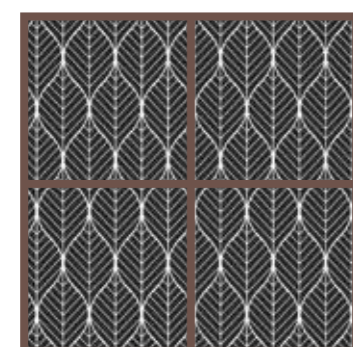

Carta Parati Losanga 02



Carta Parati Rombo 02



Carta Parati Rombo 02



Carta Parati Losanga 03



Carta Parati Losanga 03



Carta Parati Rombo 03



Carta Parati Rombo 03



Carta Parati Cemento 01

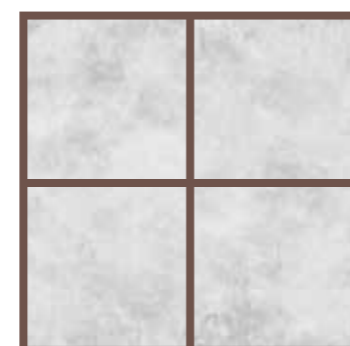

Carta Parati Cemento 01

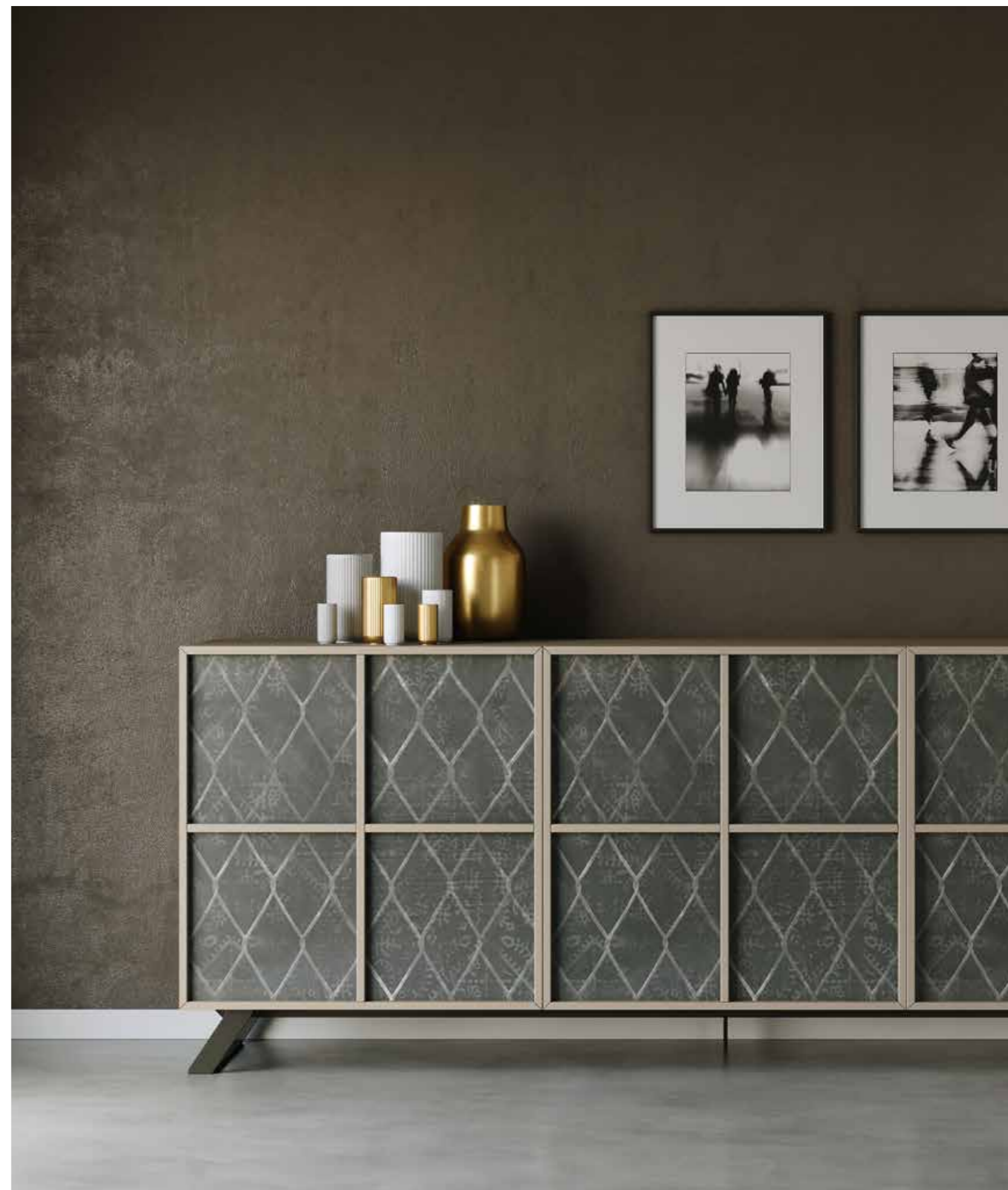

DOIMO[®] Salotti

Doimo Salotti S.r.l.
Via Montegrappa, 90
31010 Moriago della Battaglia TV Italia
T. +39 0438 890511 F. +39 0438 890590
info@doimosalotti.it www.doimosalotti.it



DOIMO
Salotti